



Preface

Thanks for choosing King Pigeon Modbus IOT Gateway BL101. Reading this manual with full attention will help you quickly learn device functions and operation methods.

Copyright

This user manual is owned by King Pigeon Communication Co., Ltd. No one is authorized to copy, distribute or forward any part of this document without written approval of King Pigeon. Any violation will be subject to legal liability.

Disclaimer

This document is designed for assisting user to better understand the device. As the described device BL101 is under continuous improvement, this manual may be updated or revised from time to time without prior notice. This Modbus Gateway is mainly used for industrial data transmission over Ethernet or 4G network. Please follow the instructions in the manual. Any damages caused by wrong operation will be beyond warranty.

Revision History

Revision Date	Version	Description	Owner
June 1, 2021	V1.0	Initial Release	HYQ



1	Brief Introduction to Device.....	6
1.1	General Description.....	6
1.2	Application Scenario.....	7
1.3	Packing List.....	7
1.4	Features.....	10
1.5	Technical Parameters.....	11
1.6	Model Selection.....	13
2	Hardware Introduction.....	13
2.1	Outline Dimension.....	13
2.2	Power Source Input.....	14
2.3	SIM Card and SD Card Slots.....	15
2.4	Program Debugging & Upgrading Interface.....	15
2.5	Device Grounding.....	15
2.6	4G Antenna.....	16
2.7	LED Indicator.....	16
2.8	RESET Button.....	17
2.9	COM & Power Output Port.....	17
2.10	WAN & LAN Port.....	18
3	Device Mounting.....	18
3.1	Wall-Mounting.....	18
3.2	DIN Rail Mounting.....	19
4	Configurator Operation.....	19
4.1	Login to Configuration Software.....	19
4.1.1	Open Configuration Software.....	19
4.1.2	Search for Device.....	20
4.1.3	Connect Gateway Device.....	21
4.2	Configuration Software Introduction.....	22
4.2.1	System Function.....	22
4.2.2	COM Port Introduction.....	24
4.2.2.1	COM Port Configuration.....	24



4.2.2.2 Add COM Port Devices.....	25
4.2.2.3 Add COM Port Device Datapoints.....	26
4.2.3 LAN Port Introduction.....	28
4.2.3.1 LAN Port Attributes Configuration.....	28
4.2.3.2 Add LAN Port Device.....	29
4.2.3.3 Add LAN Port Device Datapoints.....	31
4.2.4 WAN Port Introduction.....	31
4.2.4.1 WAN Port Attributes Configuration.....	31
4.2.4.2 Add WAN Port Device.....	32
4.2.4.3 Add WAN Port Device Datapoints.....	33
4.2.5 4G Cellular Network Introduction.....	33
4.2.6 Alarms and Events Configuration.....	34
4.2.6.1 Alarm Points Configuration.....	34
4.2.6.2 Alarm Event Configuration.....	35
4.2.7 Task Plan Configuration.....	37
4.2.8 Data Service.....	38
4.2.8.1 Transparent Transmission.....	38
4.2.8.2 Modbus RTU to Modbus TCP.....	39
4.2.8.3 Modbus TCP Server.....	41
4.2.8.4 OPC UA.....	41
4.2.9 Cloud Platform Connection.....	42
4.2.9.1 MQTT Client One.....	42
4.2.9.2 MQTT Client Two.....	44
4.2.9.3 Alibaba Cloud.....	45
4.2.9.4 HUAWEI Cloud.....	46
4.2.9.5 AWS (Amazon Web Service).....	48
4.2.9.6 King Pigeon Cloud via MQTT.....	51
4.2.9.7 King Pigeon Cloud via Modbus.....	52
5 BL101 Gateway Application Example.....	53
5.1 Device Connecting Diagram.....	53



5.2 Configuration Software Setting.....	54
5.2.1 Add Devices and Datapoints.....	54
5.2.1.1 COM Port Configuration.....	54
5.2.1.2 Add M140T to COM Port.....	55
5.2.1.3 Add M140T Datapoints.....	56
5.2.1.4 LAN Port Configuration.....	57
5.2.1.5 Add LAN Port Device S475.....	58
5.2.1.6 Add S475 Datapoint.....	59
5.2.2 M140T & S475 Data Uploading to Clouds.....	60
5.2.2.1 Modbus TCP Server Configuration.....	60
5.2.2.2 View Dat with KEPServerEX 6.....	60
5.2.2.3 OPC UA Configuration.....	61
5.2.2.4 View Data with KEPServerEX 6.....	62
5.2.2.5 Alibaba Cloud Configuration.....	63
5.2.2.6 View Data from Alibaba Cloud.....	64
5.2.2.7 HUAWEI Cloud Configuration.....	65
5.2.2.8 View Data from HUAWEI Cloud.....	67
5.2.2.9 AWS Configuration.....	68
5.2.2.10 View Data from AWS.....	69
5.2.2.11 King Pigeon Cloud via Modbus Configuration.....	70
5.2.2.12 View Data from King Pigeon Cloud via Modbus.....	71
5.2.2.13 King Pigeon Cloud via MQTT Configuration.....	72
5.2.2.14 View Data from King Pigeon Cloud via MQTT.....	73
5.2.2.15 King Pigeon Cloud MQTT Message Format.....	73
6 Firmware Upgrading.....	76
7 Warranty Term.....	76
8 Technical Support.....	76



1 Brief Introduction to Device

1.1 General Description

Developed on embedded Linux operation system for robust stability, BL101 is an innovative gateway that converts Modbus to OPC UA / MQTT protocol.

It's equipped with 1RS232/RS485(default RS485) serial port, 2 power source inputs, 1 power output, 2 Ethernet ports and 2 USB ports. Both SIM and SD card slots are available. Network can be connected either through 4G cellular or Ethernet for high transfer speed and low latency.

On downstream it supports Modbus RTU Master and Modbus TCP Master. on upstream, it supports Modbus TCP, MQTT, OPC UA, HUAWEI Cloud, Alibaba Cloud, AWS, King Pigeon Cloud, etc. Users can connect various devices to cloud, SCADA, OPC UA and MES system with this gateway. Multiple platforms and host computers can be online simultaneously.

This gateway supports TSL\SSLEncryption for data security as well as router function with switch for more industrial equipment data acquisition.

With complete functions and superior quality, it can be used in many industrial applications for remote monitoring and control.

1.2 Application Scenario

BL101 APPLICATION

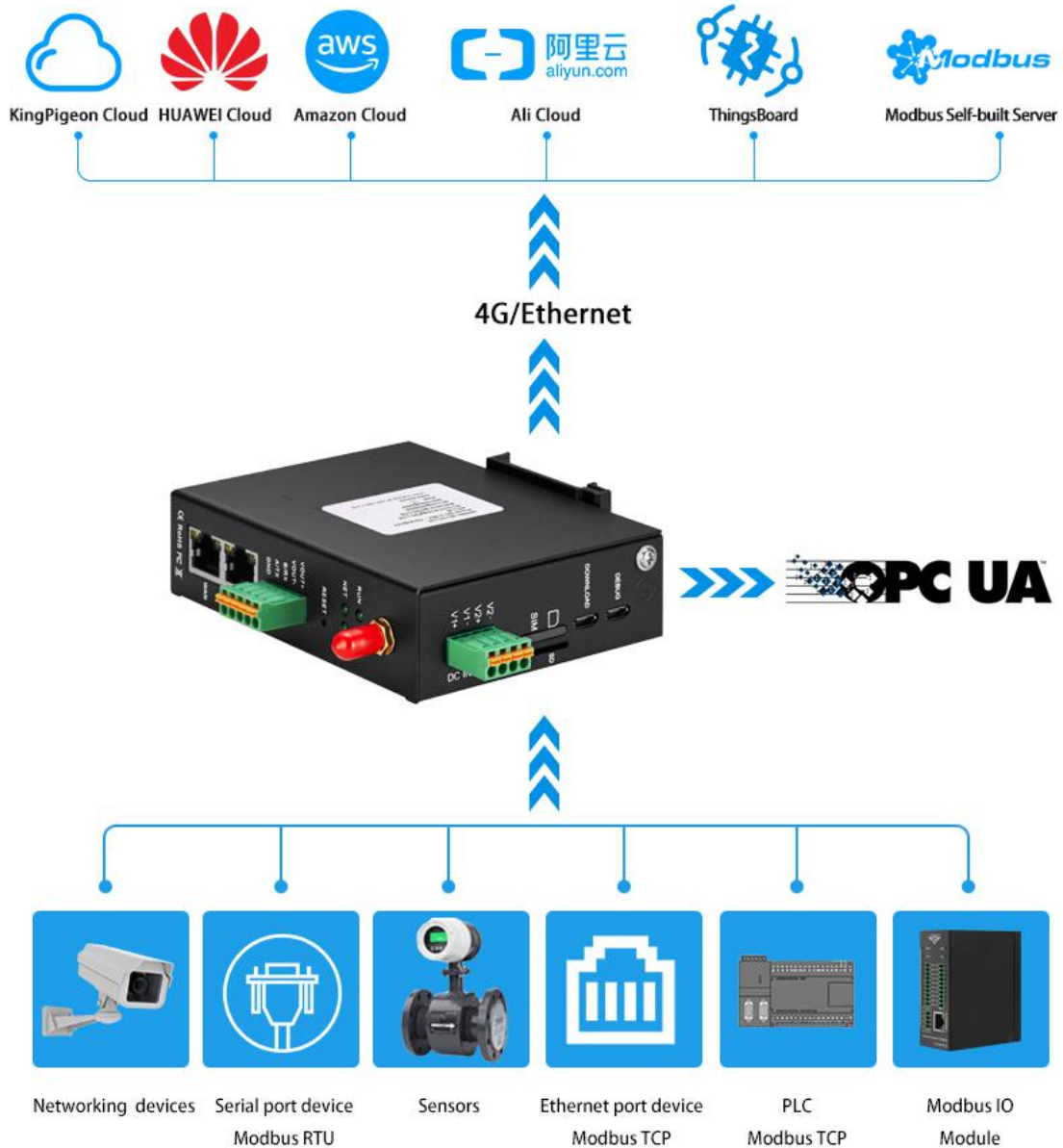

1.3 Packing List

Before operating the device, please make sure all below parts are in the package

- 1XBL101 Gateway



- 1x 4PIN 3.5mm terminal for power input



- 1x RS485/232 5PIN 3.5mm terminal for power output



- 1 x 4G SMA Cellular Network Antenna



- 2 x Wall-mounting Clip Kit

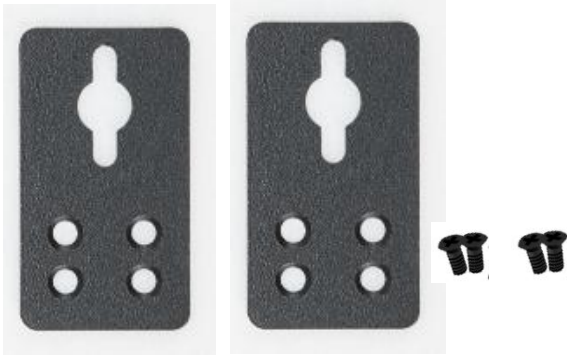

- 1 x DIN Rail Clip Kit



- 1 x User Manual (Softcopy in PDF format)
(Note: Please scan QR code to download)

- 1 x Data Card Picking PIN



- 1 x Product Qualification Certificate



- 1 x Warranty Card



Note: If any of the above items are missing, please contact King Pigeon Sales team.



1.4 Features

- Downlink: support Modbus RTU Master、 Modbus TCP Master
Uplink: support Modbus TCP, MQTT, OPC UA, HUAWEI Cloud, Alibaba Cloud.
- Support 9-36V DC power supply with terminal connection. 2 channels of power input redundancy design with inverse connection protection. Either channel can be selected for power input.
- 1 power output channel. Output voltage is the same as power input voltage
- 1 RS485 (can be RS232 if required)
- Baud rate 2400bps-115200bps, stop bit supports 1, 2 bits, data bit supports 7, 8 bits. Parity supports None, Odd, Even.
- Support 2 RJ45 Ethernet connection, 1WAN and 1LAN. Data of equipment connected to LAN, WAN or cascade switch can be acquired. Both network link and rate indicators are available. Built-in isolation transformer for up to 2KV electromagnetic insulation.
- Support POE PD(Powered Device) for saving wiring cost (Optional function)
- Support TSL\SSL encryption for data security
- Support router function to provide network for other devices
- Support 4G network with APN setting. Ethernet network will be used first if it's available. If Ethernet is disconnected, it will shift to 4G cellular network automatically.
- Support Modbus to Modbus TCP, transparent transmission
- Support returning to factory setting (Long pressing RESET until RUN indicator is off) to avoid parameter setting error
- Support hardware and software watchdog for high reliability
- Metal case with IP30 protection grade. Safety isolation between metal case and system , especially suitable for industrial site applications
- Compact size: 30mm*83mm*110mm; Support wall-mounting and DIN rail mounting



1.5 Technical Parameters

Item	Parameter	Description
Power Source	Input Voltage	DC 9~36V
	Consumption	Normal 85mA@12V, Max 117mA@12V
	Wiring	Support inverse connection protection
Network Interface	Interface Spec	2 x RJ45, 10/100Mbps, Adaptive MDI/MDIX。
	Port Protection	ESD ±16kV(Contact); ±18kV(Air) EFT 40A (5/50ns) Lightening 6A (8/20µs)
Serial Port	Serial Port	1 x RS232/RS485 (Default is RS485, Optional RS232)
	Baud Rate	2400bps-115200bps
	Data Bit	7,8
	Parity Bit	None, Even, Odd
	Stop Bit	1, 2
	Port Protection	ESD ±8kV (Contact); ±15kV(Air); EFT 2KV, 40A (5/50ns)。
Power Output	Output Voltage	1 channel 9~36 V DC (Equal to input power voltage)
SIM Card Slot	Qty	1
	Spec	Drawer design, Support 1.8V/3V SIM/UIM card (NANO)
	Protection	Inbuilt 15KV ESD protection
SD Card Slot (Reserved function)		Reserved for future development
USB Port	Qty	1* program downloading+1*program debugging
	Spec	Micro USB OTG
	Protection	Over Current Protection
4G (Optional)	Antenna Qty	1
	Antenna Type	SMA
	L-E version	GSM/EDGE:900,1800MHz WCDMA:B1,B5,B8 FDD-LTE:B1,B3,B5,B7,B8,B20 TDD-LTE:B38,B40,B41
	L-CE version	GSM/EDGE:900,1800MHz WCDMA:B1,B8 TD-SCDMA:B34,B39 FDD-LTE:B1,B3,B8



		TDD-LTE:B38,B39,B40,B41
	L-A version	WCDMA:B2,B4,B5 FDD-LTE:B2,B4,B12
	L-AU version	GSM/EDGE:850,900,1800MHz WCDMA:B1,B2,B5,B8 FDD-LTE:B1,B3,B4,B5,B7,B8,B28 TDD-LTE:B40
	L-AF version	WCDMA:B2,B4,B5 FDD-LTE:B2,B4,B5,B12,B13,B14,B66,B71
	CAT-1 version	GSM:900,1800 FDD-LTE:B1,B3,B5,B8 TDD-LTE:B34,B38,B39,B40,B41
Indicator	RUN	Steady light if device is powered on Flickering if device is running Off if device is not running
	NET	Flickering if communication is over Ethernet network Steady light if communication is over 4G network Off if no data communication
	TXD	Flickering if device is transmitting data Off if there's no data transmitting
	RXD	Flickering if device is receiving data Off if there is no data receiving
Software Parameter	Network Protocol	IPV4, TCP/UDP, DHCP, DNS
	IP Retrieving	Static IP/DHCP
	Transmission	Support Transparent Data Transmission
	DNS	Support Domain Name Resolution
	Configuration	PC configuration, support WIN XP/WIN 7/WIN 8/WIN 10
	Cache Size	Transmit: 8Kbyte, Receive: 8Kbyte。
	Register Pack	Support custom registration package
Heartbeat PCK	Support custom heartbeat package	
Safety Certification	MTBF	≥100,000 hours
	EMC	EN 55022: 2006/A1: 2007 (CE &RE) Class B
		IEC 61000-4-2 (ESD) Level 4
		IEC 61000-4-3 (RS) Level 4
		IEC 61000-4-4 (EFT) Level 4
	IEC 61000-4-5 (Surge)Level 3	



		IEC 61000-4-6 (CS)Level 4
		IEC 61000-4-8 (M/S) Level 4
	Other	CE, FCC
Environment	Working	-40~80°C, 5~95% RH
Condition	Storage	-40~85°C, 5~95% RH
Others	Case Material	Metal
	Size	30mm×83mm×110mm(L*W*H)
	Protection	IP30
	Net Weight	291.2g
	Mounting	Wall-mounting, DIN Rail mounting

1.6 Model Selection

Model NO.	WAN	LAN	COM (Default RS485) (RS485/RS232 optional)	OPC-UA	4G	POE PD
BL101	√	√	√	X	√	Optional
BL101E	√	√	√	X	X	Optional
BL101UA	√	√	√	√	X	Optional

2 Hardware Introduction

2.1 Outline Dimension

Unit: mm

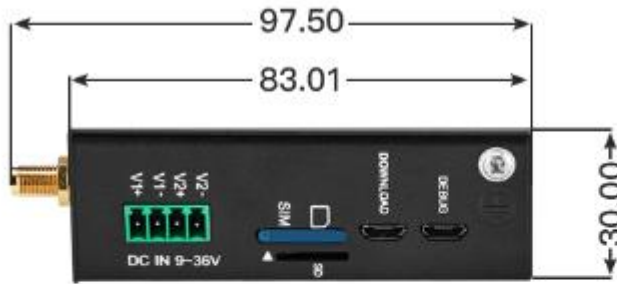

Top View

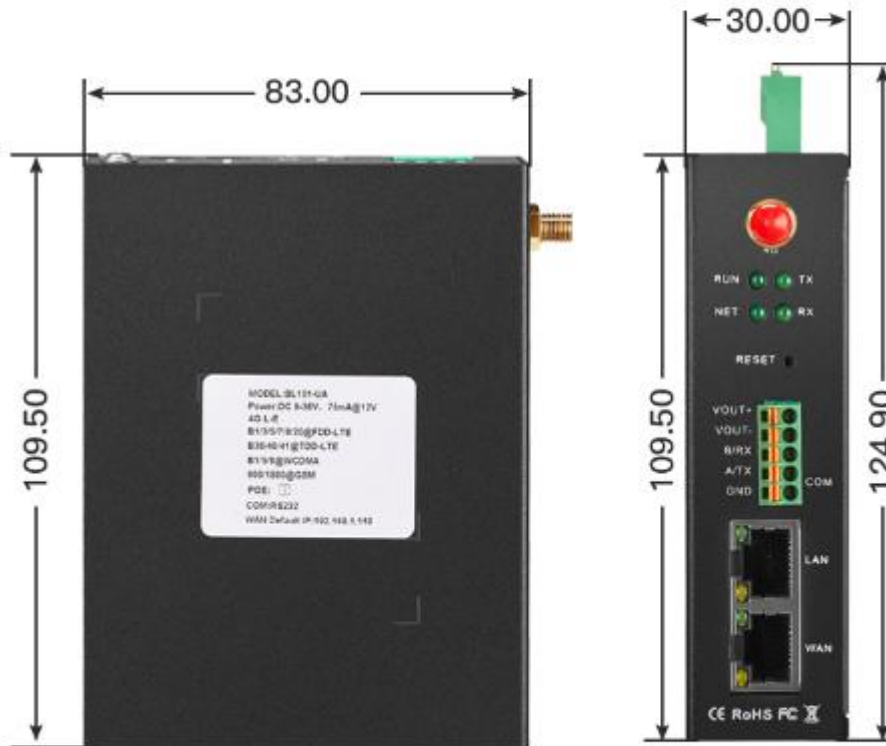

Side view

Main view

2.2 Power Source Input



2 optional power source input channels, support 9-36VDC voltage input, support

inverse connection protection.

2.3 SIM Card and SD Card Slots



Before inserting or removing SIM card, please make sure device is turned off. Insert SIM card picking PIN to the small hole of card slot and eject the card slot with tiny force.

Note: Place the device like above picture to insert/remove SIM card

2.4 Program Debugging & Upgrading Interface



DEBUG USB port is for program debugging. DOWNLOAD USB port is for program upgrading.

2.5 Device Grounding



Before connecting the device, please do equipment grounding with grounding screw to prevent electromagnetic interference

2.6 4G Antenna

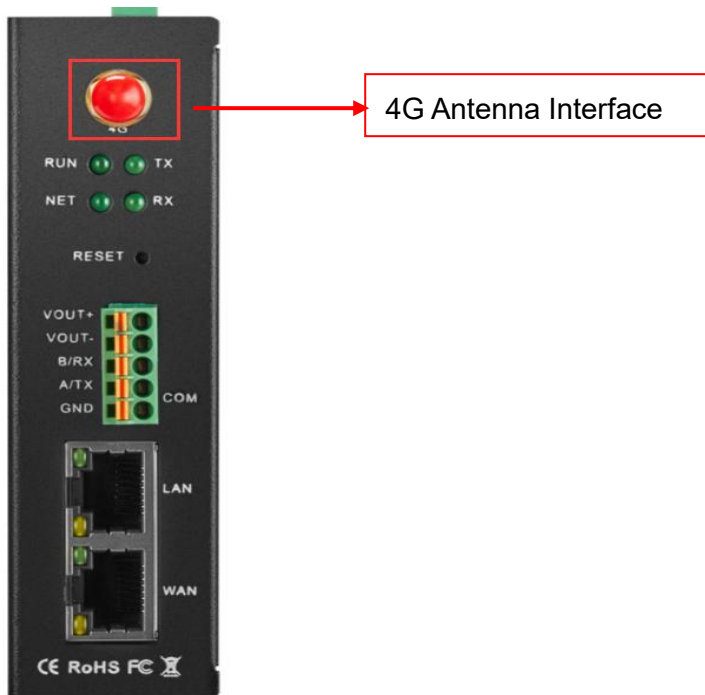

2.7 LED Indicator



LED Indicator Introduction			
Item Name		Status	Description
RUN	Device Running	Flickering	Device is running
		Off	Device faulty
NET	Ethernet/4G Network	Flickering	Ethernet network
		On	4G network
		Off	No communication
TX	Data Transmitting	Flickering	Serial port is transmitting data
		Off	No data transfer from serial port
RX	Data Receiving	Flickering	Serial port is receiving data
		Off	No data is received in serial port
Note: RUN indicator will be on if device is powered. If it's not on, please check whether there's reverse wiring or power source problem.			

2.8 RESET Button

Once gateway has run for some time, use a tiny stick to press Reset button for about 10 seconds until RUN indicator is off. Then Gateway will restart and return to factory setting.



2.9 COM & Power Output Port

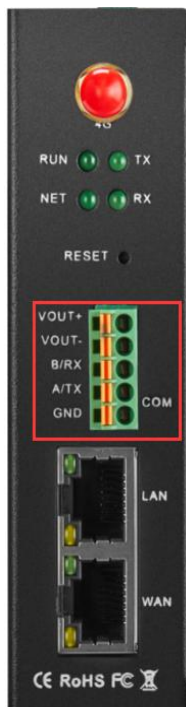

RS485/RS232 & Power Output Terminal	
Item	Description
VOUT+	Power Output Positive Terminal
VOUT-	Power Output Negative Terminal
B/RX	RS485 Data-(B)/Receiving Data
A/TX	RS485 Data+(A)/Transmitting Data
GND	Grounding
Note: Power output voltage is equal to power input voltage: 9~36VDC.	

2.10 WAN & LAN Port



Ethernet Port			
Indicator	Color	Status	Description
Rate	Green	On	100Mbps mode
		Off	10Mbps mode
Link	Yellow	On	Connected
		Flickering	Transferring data
		Off	Disconnected

3 Device Mounting

BL101 Gateway can be placed on desk, mounted on the wall and DIN Rail

3.1 Wall-Mounting

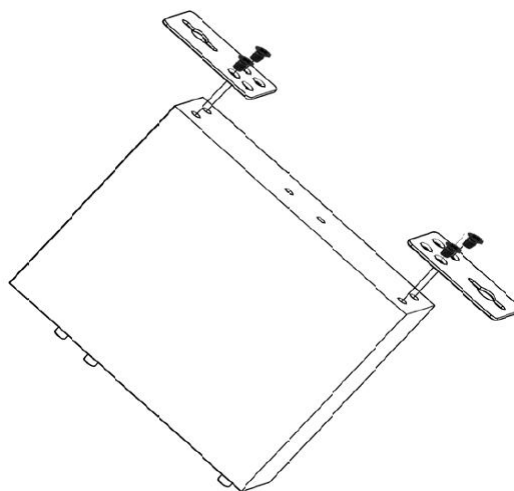

Wall-Mounting

3.2 DIN Rail Mounting

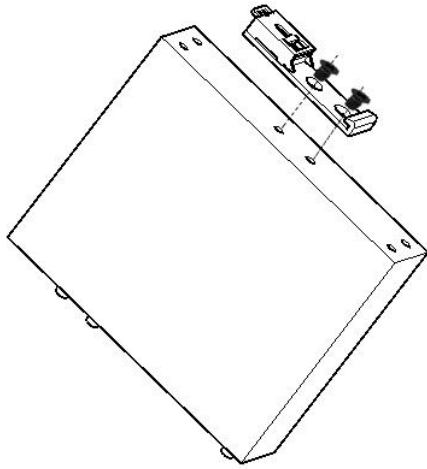

Clip Assembling

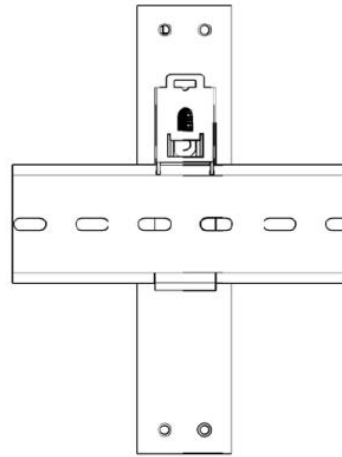

DIN Rail Mounting

4 Configurator Operation

4.1 Login to Configuration Software

Connect BL101 to router or switch through WAN port with standard direct network cable or cross network cable. Make sure BL101 and PC are in the same local area network. If it's necessary to connect the gateway to PC directly, use standard cross network cable to connect through BL101 LAN port. (If BL101 is connected to PC directly, PC IP must be specified to 192.168.3.1 as default LAN IP of gateway is 192.168.3.1 from factory setting)

Note: WAN port IP is retrieved automatically, LAN port IP is 192.168.3.1 from factory setting

4.1.1 Open Configuration Software

Double click  BL10x_Configurator_V1.0 on PC to run BL101 configuration software and enter below page

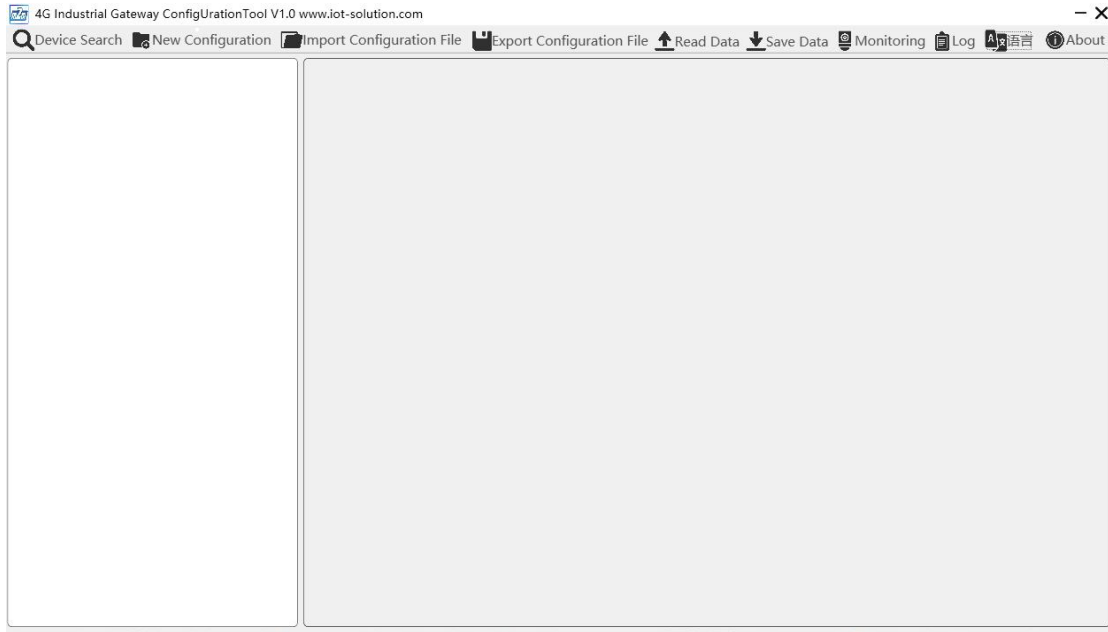

4.1.2 Search for Device

Click Device Search to get all devices which are in the same local area network with PC. If no device is found, please follow the procedure on the right notice box to check the root cause. Below is the example of connecting Gateway BL101 with switch through WAN. A device with IP 192.168.1.165 is searched out.

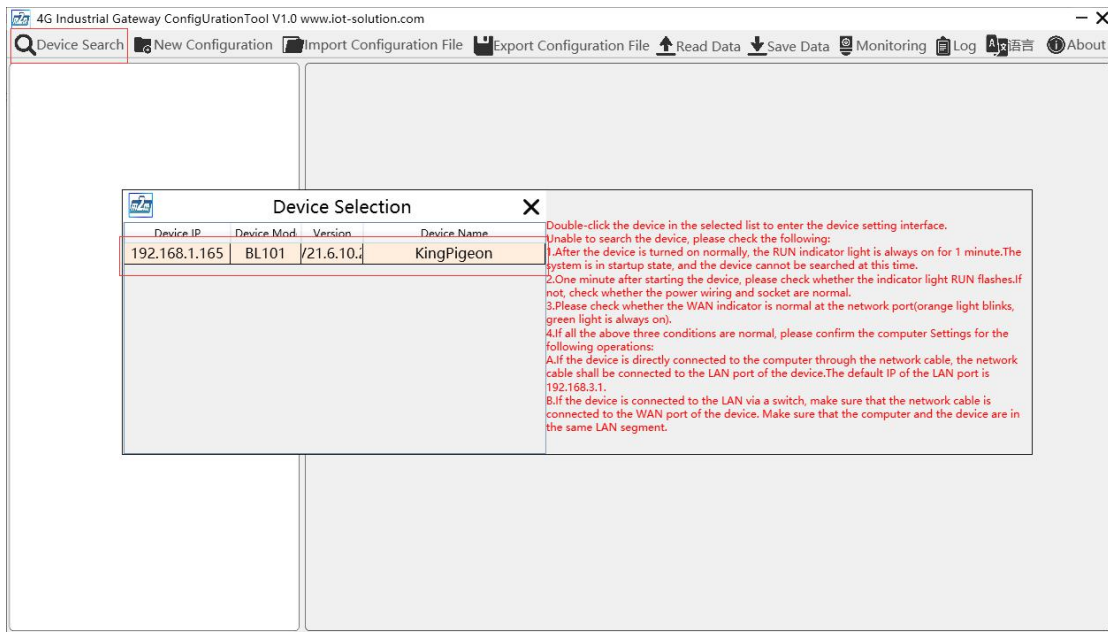

4.1.3 Connect Gateway Device

Double click the device to be configured (For example, double click device with IP 192.168.1.165) . Reading success message will be shown in prompting box. Click confirm to enter configuration page.

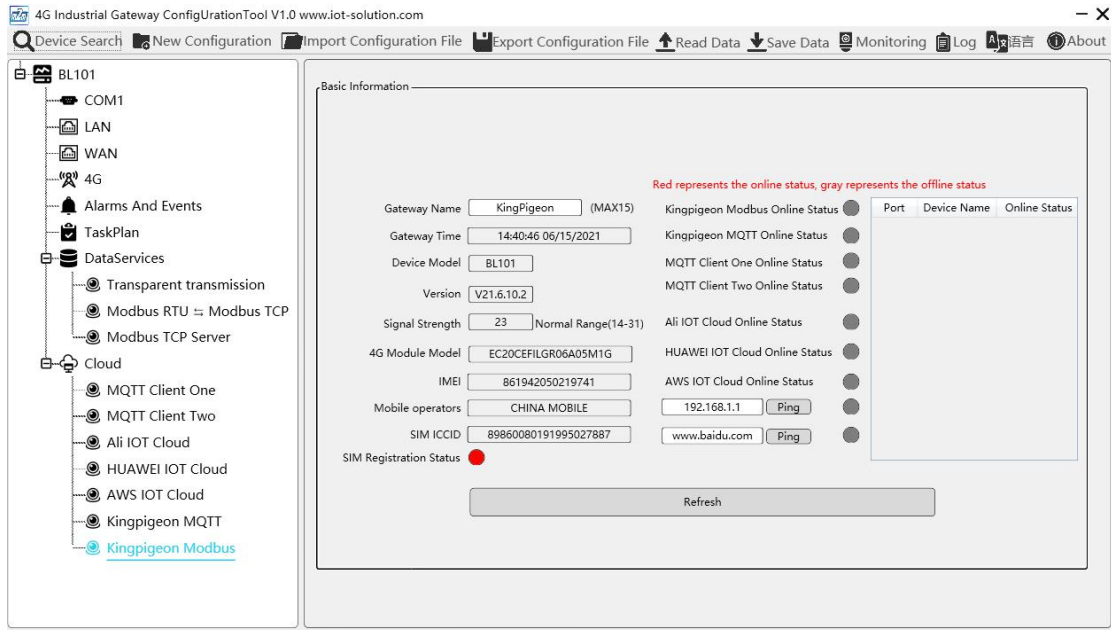

4.2 Configuration Software Introduction

4.2.1 System Function

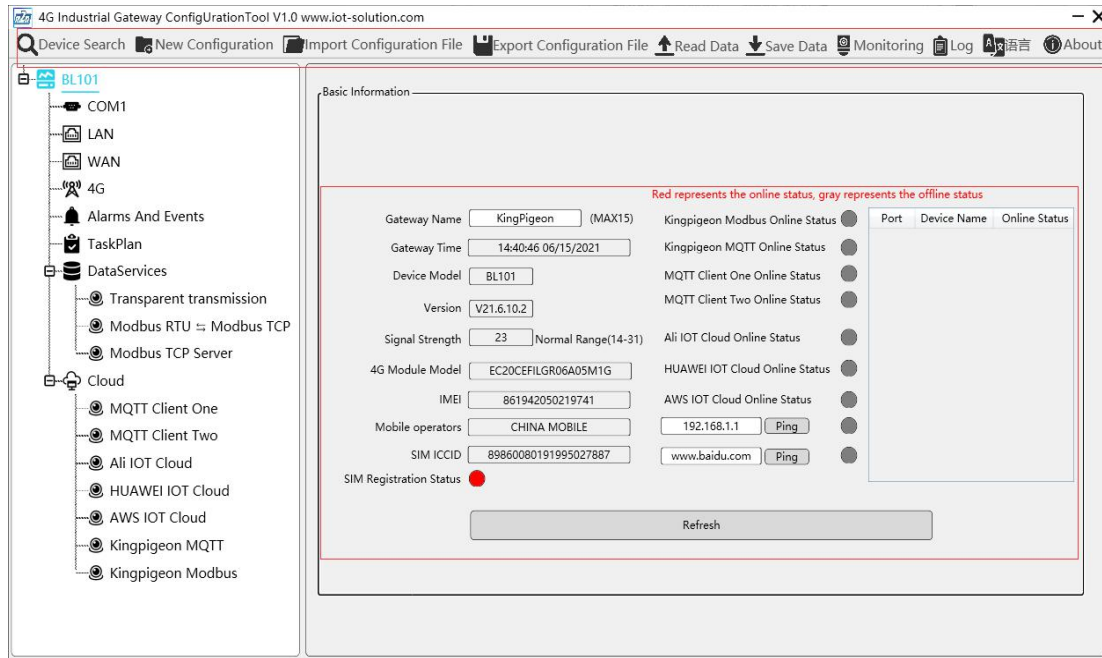

System Function	
Item	Description
Device Search	Search for all BL101 gateways in the same loca area network
New Configuration	Open a new default configuration file
Import Configuration File	Import gateway configuration file
Export Configuration File	Export gateway configuration file
Read Data	Read logged-in BL101 gateway configuration parameters
Save Data	Save all configuration parameters by clicking it
Monitoring	Monitor connected device value
Log	System running log. If device issue, click save log to send it to specified email box
Language	Click it to change language to English
About	Software Version, Issue Date, Firmware upgrade information

Basic Information of Gateway BL101	
Item	Description
Gateway Name	Default Name is KingPigeon



Modbus to MQTT IoT Gateway

-BL101

Gateway Time	Local time of reading gateway
Device Model	Read device model number
Version	Read device version
Signal Strength	4G module signal value. If it's less than 14, it means weak signal. Full signal value is 31
4G Module Model	Read 4G module model. If it's null, it means no 4G module
IMEI	Device IMEI code
Mobile Operators	SIM card service provider
SIM ICCID	Read SIM card ICCID
SIM Registration Status	Red indicates SIM card is registered. Gray indicates SIM card is not registered,
King Pigeon Cloud via Modbus Online Status	Red indicates King Pigeon cloud is connected via Modbus Gray indicates King Pigeon cloud is unconnected via Modbus
King Pigeon Cloud via MQTT Online Status	Red indicates King Pigeon cloud is connected via MQTT Gray indicates King Pigeon cloud is unconnected via MQTT
MQTT Client One Online Status	Red indicates MQTT Client One is connected Gray indicates MQTT Client One is unconnected
MQTT Client Two Online Status	Red indicates MQTT Client Two is connected Gray indicates MQTT Client Two is unconnected
Ali IOT Cloud Online Status	Red indicates Ali Cloud is connected Gray indicates Ali Cloud is unconnected
HUAWEI IOT Cloud Online Status	Red indicates HUAWEI Cloud is connected Gray indicates HUAWEI Cloud is unconnected
AWS IOT Cloud Online Status	Red indicates AWS is connected Gray indicates AWS is unconnected
192.168.1.1 Ping	Default factory setting Ping 192.168.1.1 gateway, IP can be changed. It's gateway through WAN. Click Ping button to check local area network status. Red indicates local area network is OK. Gray indicates local area network problem.
www.baidu.com Ping	Default factory setting Ping baidu website. Web address can be changed. Wide area network status can be checked by clicking Ping. Red indicates wide area network is OK. Gray indicates internet communication problem.
Device Online Status Prompting Box	Red indicates gateway is communicating with slave devices Gray indicates gateway fails to communicate with slave device

Refresh	Refresh basic information of gateway
---------	--------------------------------------

4.2.2 COM Port Introduction

4.2.2.1 COM Port Configuration

Double click COM1. Serial Port Attributes box will pop up for configuration

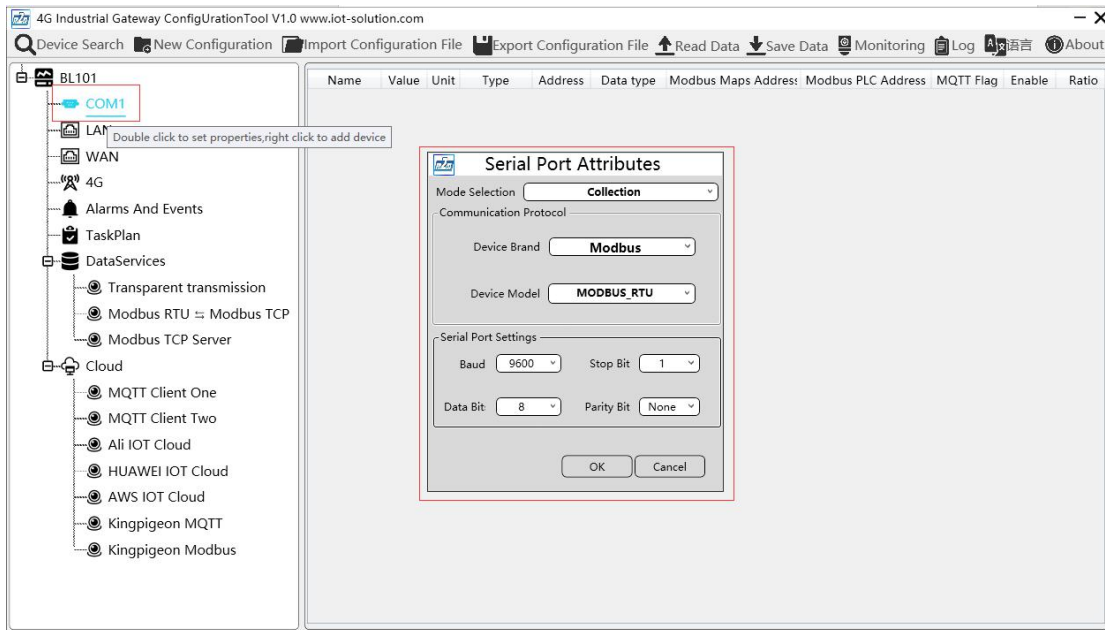

Serial Port Attributes		
Item	Description	Default
Mode Selection	Select mode: Collect/Transparent Transmission/Modbus RTU to Modbus TCP	Collect
Protocol	Device Brand	Modbus
	Device Model	Modbus RTU
Serial Port Settings	Baud Rate	Select from "2400", "4800", "9600", "19200", "38400", "57600", "115200"
	Stop Bit	Select "1Bit" or "2Bit"
	Data Bit	Select "7Bit" or "8Bit"
	Parity Bit	Select "None", "Even", "Odd"
OK	Confirm COM configuration	

Cancel	Cancel COM port configuration	
--------	-------------------------------	--

4.2.2.2 Add COM Port Devices

Right click COM1 and click Add to add new data logging device. Device configuration box will pop up. For the added device, double click it to show device configuration information. Right click to delete device.

Note: Maximum 50 Modbus RTU devices' data can be collected through COM

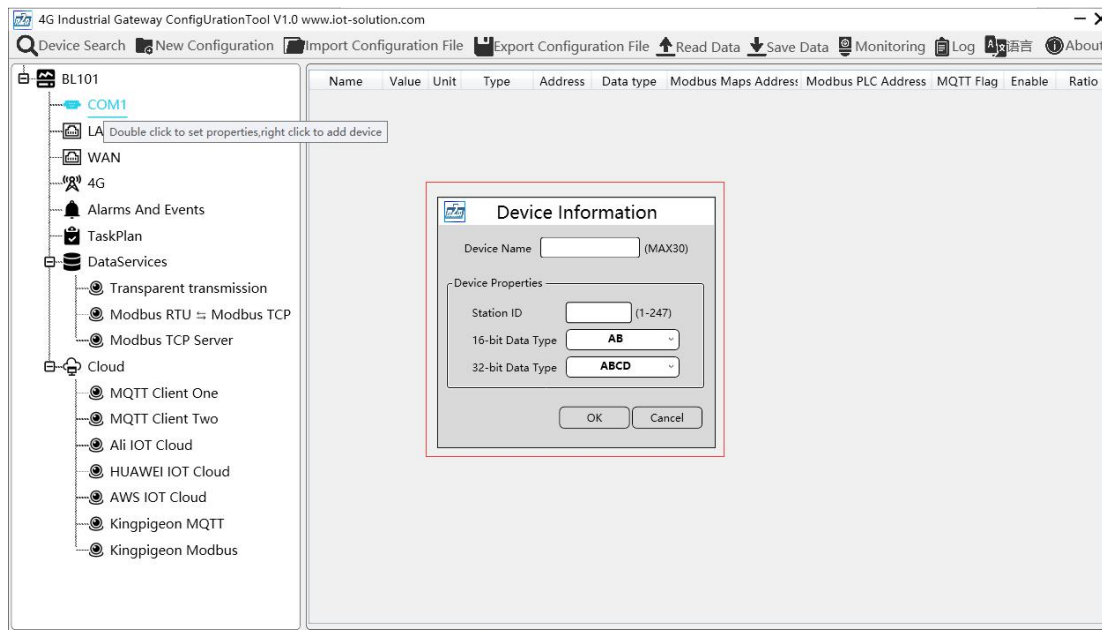
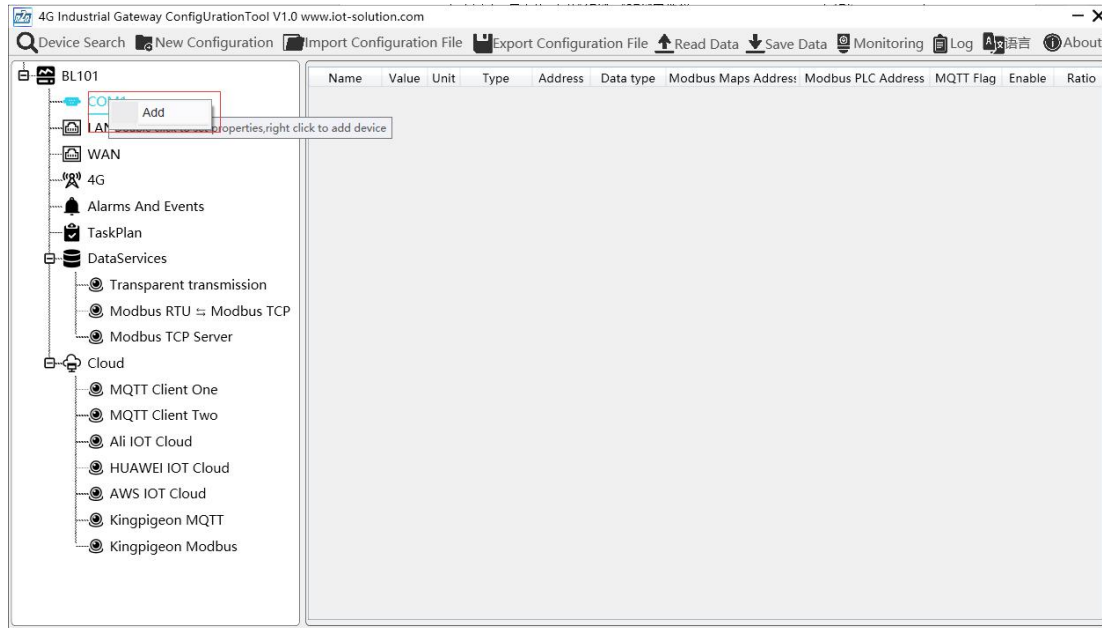

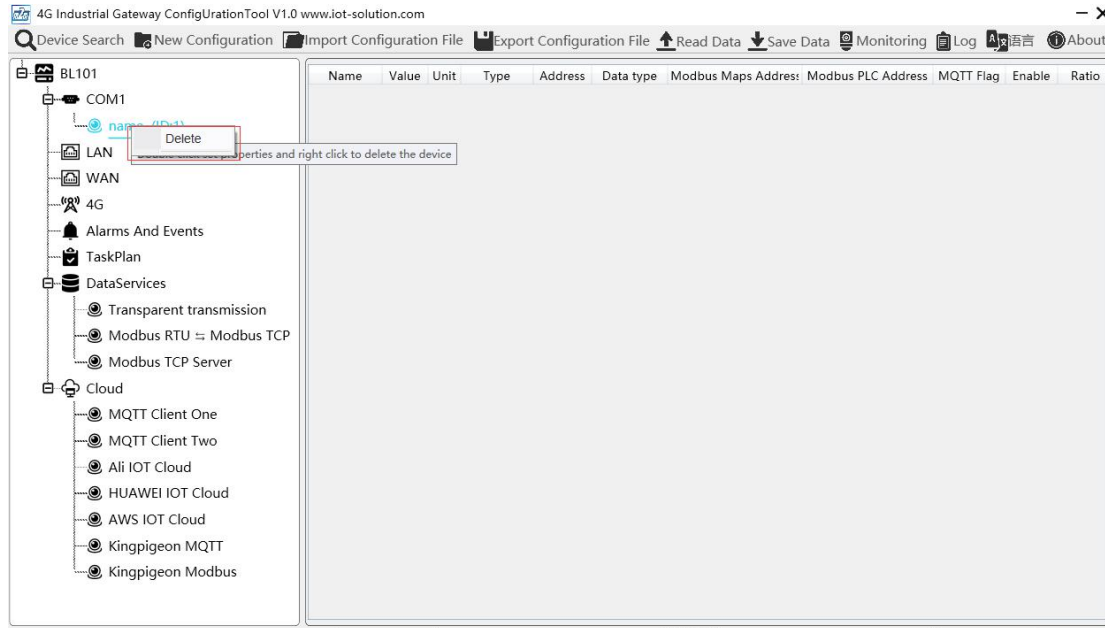

Device Information			
Item	Description	Default	
Device Name		Name of Data Collecting Device	
Device Properties	Station ID	Data Collecting Device Modbus Communication Address	
	16-bit Data Type	Select "AB" or "BA"	AB
	32-bit Data Type	Select "ABCD", "DCBA", "BADC", "CDAB"	ABCD
OK		Confirm device configuration	
Cancel		Cancel device configuration	

4.2.2.3 Add COM Port Device Datapoints

Click device name and then right click the box on the right. Add box will pop up. Click Add to enter datapoint configuration box. Right click the added datapoint to delete it. Double click the datapoint to edit it. To add more datapoints, right click the box and perform the same procedures.



Modbus to MQTT IoT Gateway

-BL101

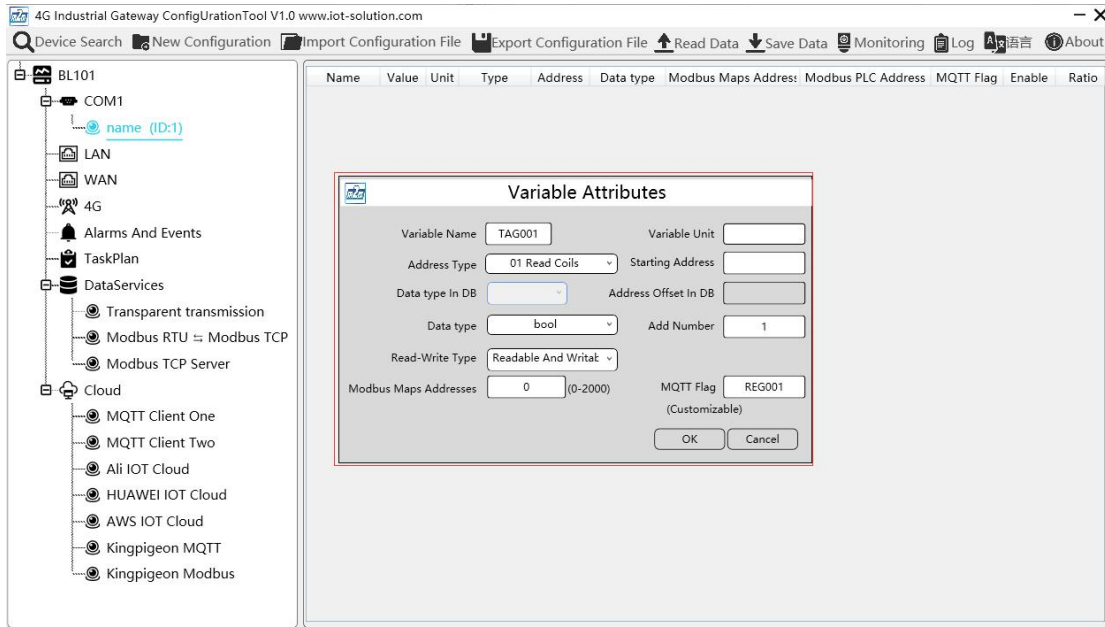
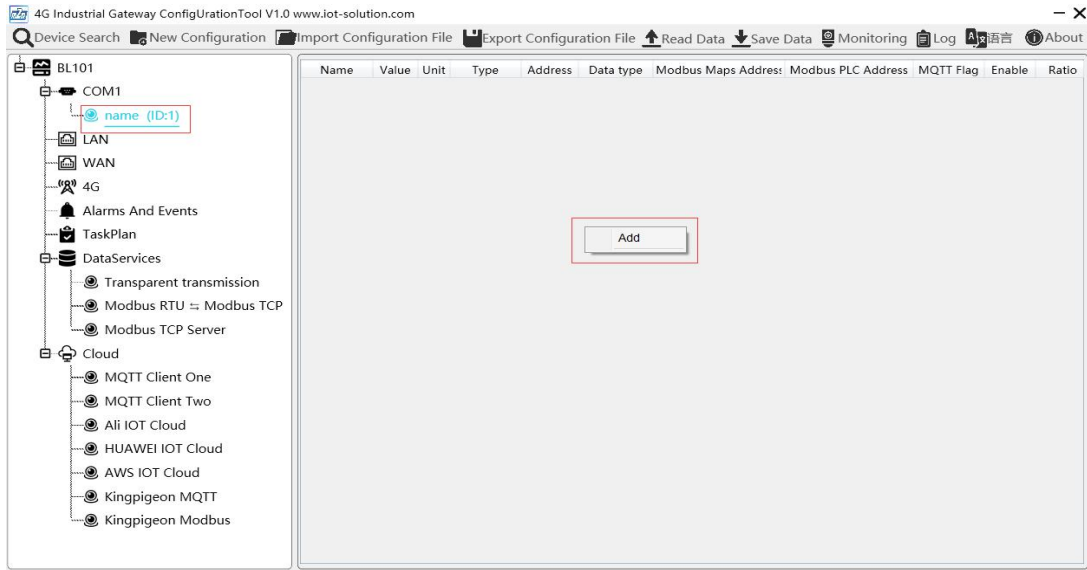

Datapoints Configuration	
Item	Description
Variable Name	Name of Added Datapoint
Variable Unit	Datapoint unit
Address Type	Select datapoint Modbus function code: 01 read holding coil, 02 read input coil, 03 read holding register, 04 read input register
Starting Address	Datapoint address
Data Type	Select from Bool, 16-bit unsigned integer, 16-bit signed integer, 32-bit unsigned integer, 32-bit signed integer, 32-bit single precision floating point
Add Number	Datapoint qty

Read-Write Type	Select “read only”, “read and write”
Ratio	Only set for numeric data. Data can be magnified or minified with certain ratio before sending to cloud
Modbus Mapping Address	Address in Gateway where datapoints are stored. Boolean: 0~2000 addresses, Numeric: 0-2000 addresses.
MQTT flag	Datapoint MQTT mark, can be any mark
OK	Confirm datapoint setting
Cancel	Cancel datapoint setting

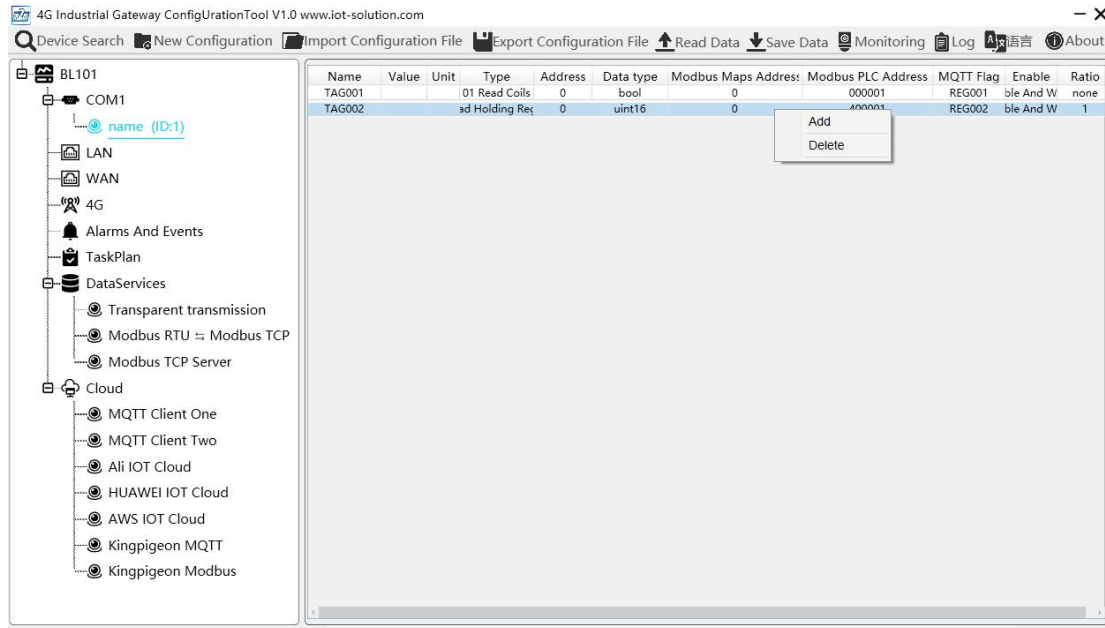

Right click datapoint to delete it and double click it to edit it.

4.2.3 LAN Port Introduction

4.2.3.1 LAN Port Attributes Configuration

Double click LAN port to enter setting page. Factory default IP of LAN is 192.168.3.1. Auto IP address distribution and routing functions are turned off from factory setting in default

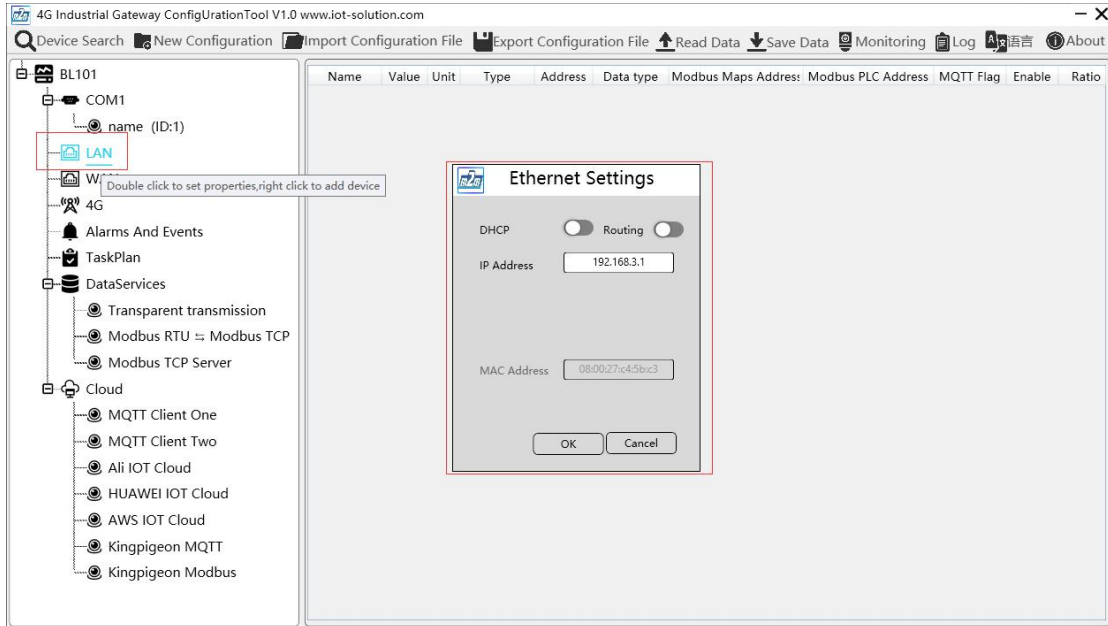

LAN Port Configuration	
Item	Description
DHCP	Green indicates auto IP distribution for LAN is enabled Gray indicates auto IP distribution for LAN is turned off
Routing	Green indicates routing function is enabled. Gray indicates routing function is turned off
IP Address	LAN port IP Address
MAC	LAN port MAC
OK	Confirm LAN port Setting
Cancel	Cancel LAN port setting

4.2.3.2 Add LAN Port Device

Right click LAN and click Add to enter device configuration page. Device can be connected directly with Gateway BL101 through LAN or through switch which is connected with LAN.

Note: Total 50 devices can be connected through LAN and WAN

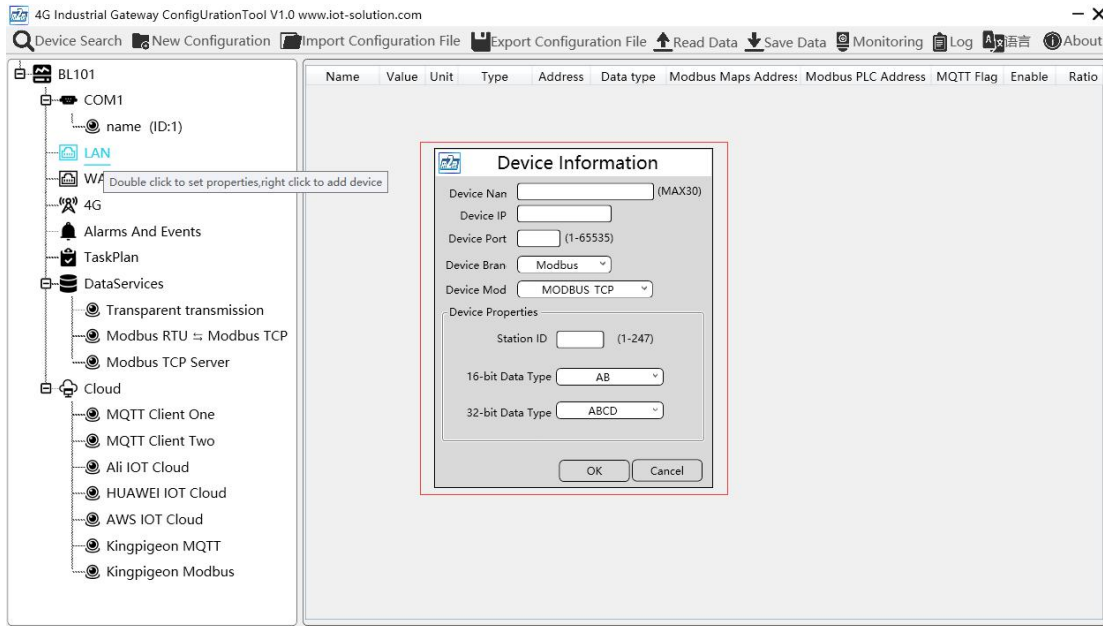
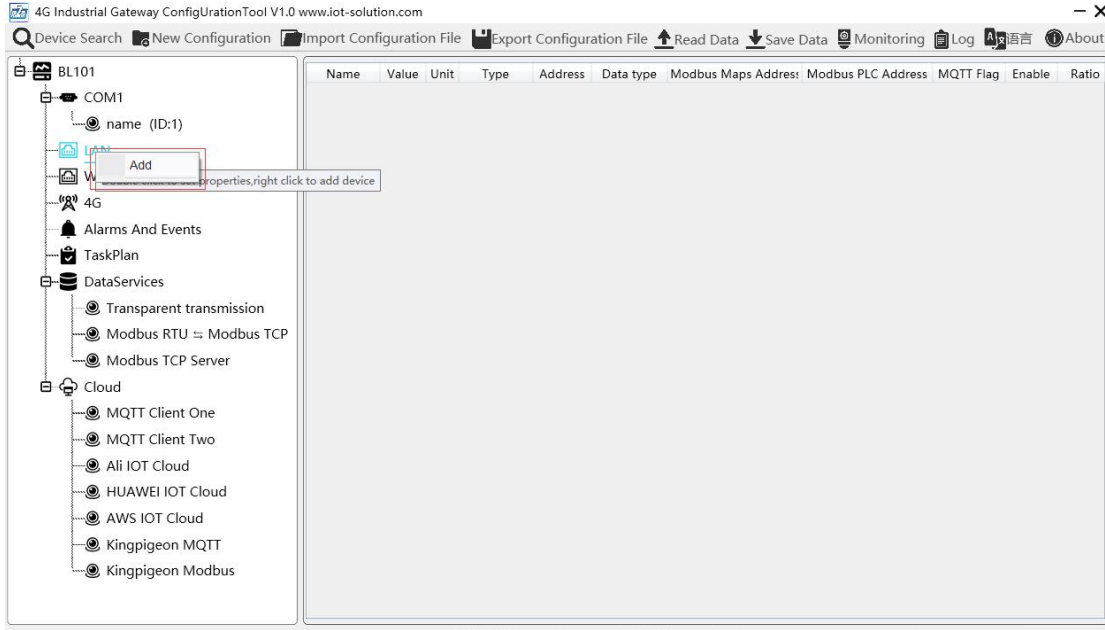

LAN Port Device Configuration	
Item	Description
Device Name	Name of Device to connect through LAN
Device IP	Set IP Address of LAN port device
Device Port	Set LAN device port
Device Brand	Modbus
Device Model	Modbus TCP
Station ID	LAN port device Modbus communication address
16-bit Data Type	Select "AB" or "BA"
32-bit Data Type	Select "ABCD", "DCBA", "BADC" or "CDAB"

OK	Confirm LAN port device setting
Cancel	Cancel LAN port device setting

4.2.3.3 Add LAN Port Device Datapoints

Follow the same procedure of adding datapoints for COM port device to add datapoints of LAN port device

[Add COM Device Datapoint](#)

4.2.4 WAN Port Introduction

4.2.4.1 WAN Port Attributes Configuration

Double click WAN to enter configuration box

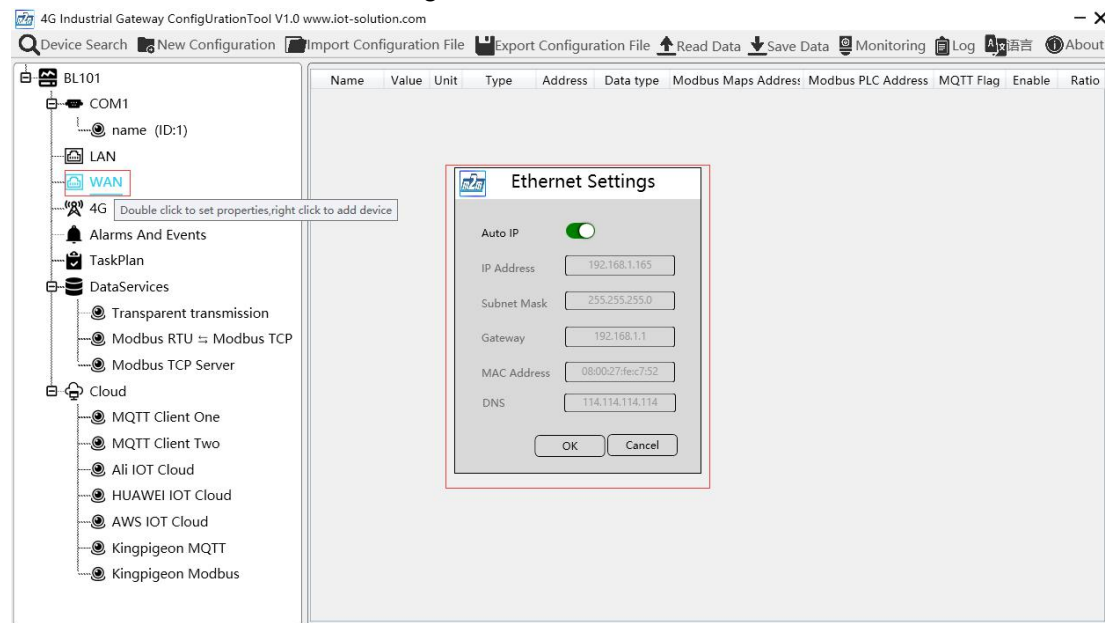

WAN Port Configuration	
Item	Description
Auto IP	Green indicates auto retrieving IP Gray indicates IP is specified
IP Address	Current IP Address of WAN Port
Subnet Mask	Current WAN Subnet Mask
Gateway	Current WAN Gateway Address
MAC Address	WAN port MAC address
DNS	Current WAN port DNS server
OK	Confirm WAN port setting



Cancel Cancel WAN port setting

4.2.4.2 Add WAN Port Device

Right click WAN and then click add to enter device configuration page

More devices can be connected with switch connecting WAN port

Note: Total 50 Modbus TCP devices can be connected through LAN and WAN

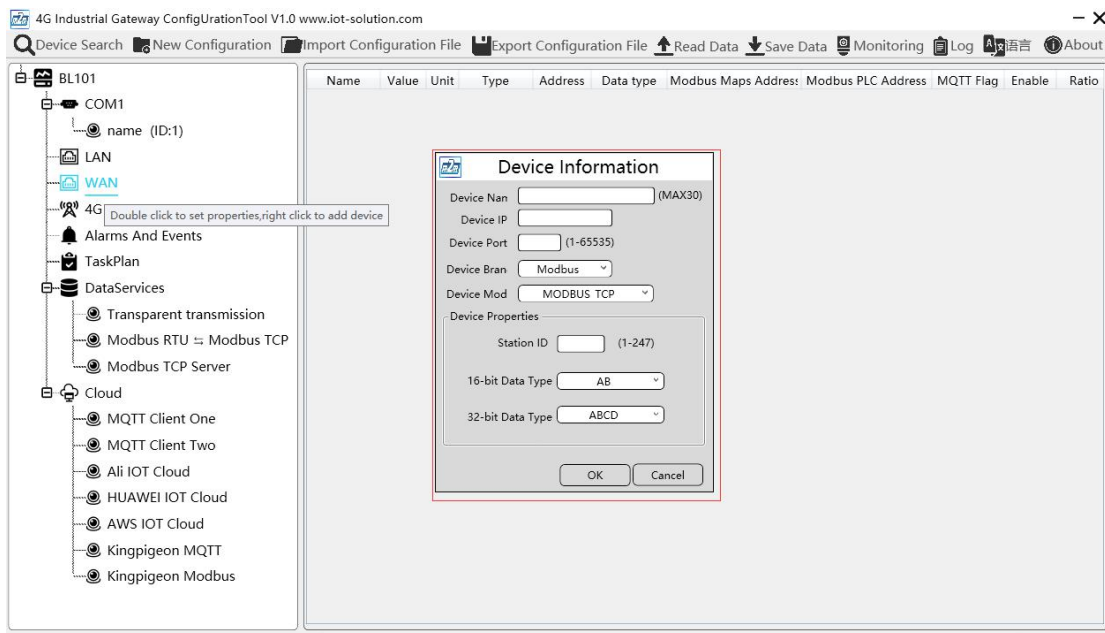
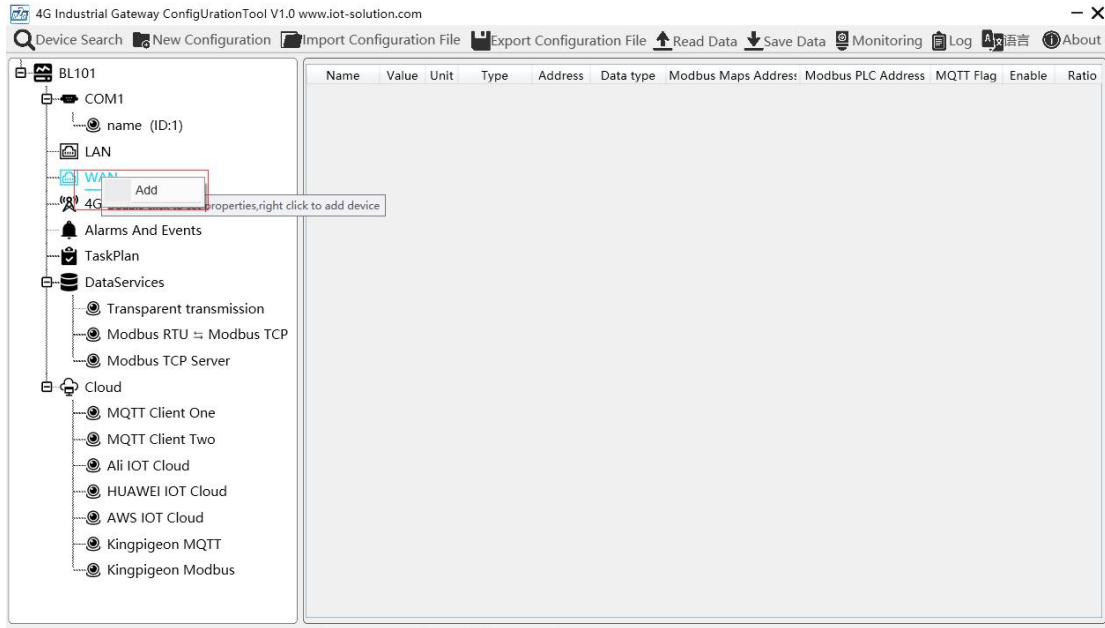

WAN Port Device Configuration

Item	Description
Device Name	Name of WAN Port Device
Device IP	WAN Port device IP address
Device Port	WAN port device Port
Device Brand	Modbus
Device Model	Modbus TCP
Station ID	WAN port device Modbus communication address
16-bit Data Type	Select "AB" or "BA"
32-bit Data Type	Select "ABCD", "DCBA", "BADC" or "CDAB"
OK	Confirm WAN port device setting
Cancel	Cancel WAN port device setting

4.2.4.3 Add WAN Port Device Datapoints

Follow the same procedure of adding datapoints for COM port device to add datapoints of WAN port device

[Add COM Port Device Datapoints](#)

4.2.5 4G Cellular Network Introduction

Double click 4G to enter APN setting box.

Note: It's not necessary to set APN for China mainland 4G network. If no 4G module in the device, it's not needed to set it either

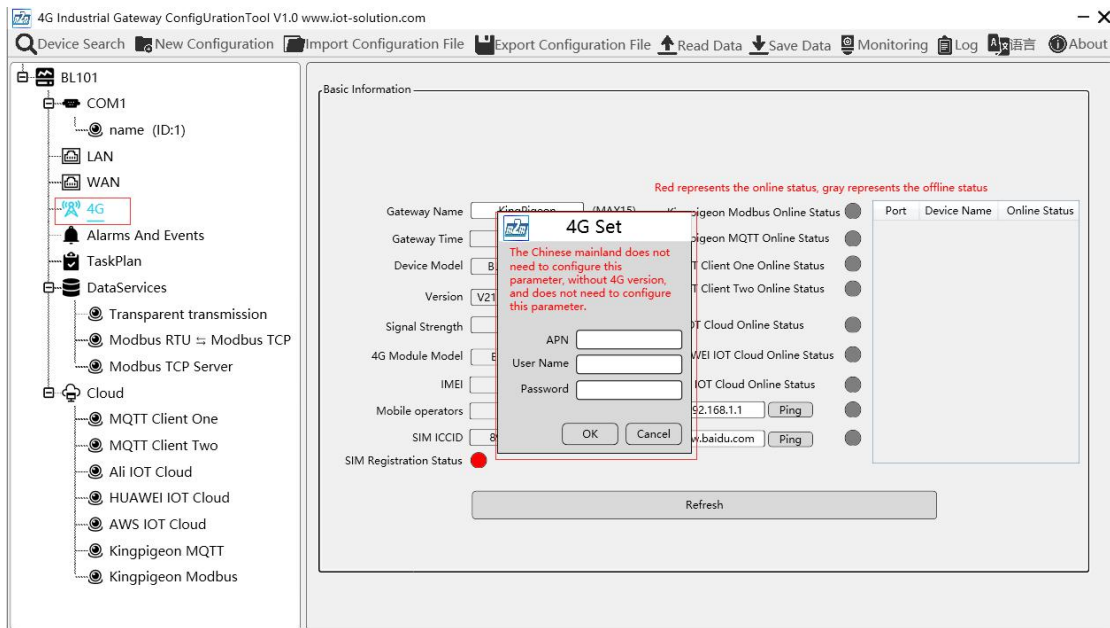

4G Configuration	
Item	Description
APN	Access Point Name of SIM card cellular network
User Name	User Name of SIM card cellular network
Password	Password of SIM card cellular network

4.2.6 Alarms and Events Configuration

Double click Alarms and Events to enter setting box. Alarm points, actions and alarm recovery actions can be set according to requirement

4.2.6.1 Alarm Points Configuration

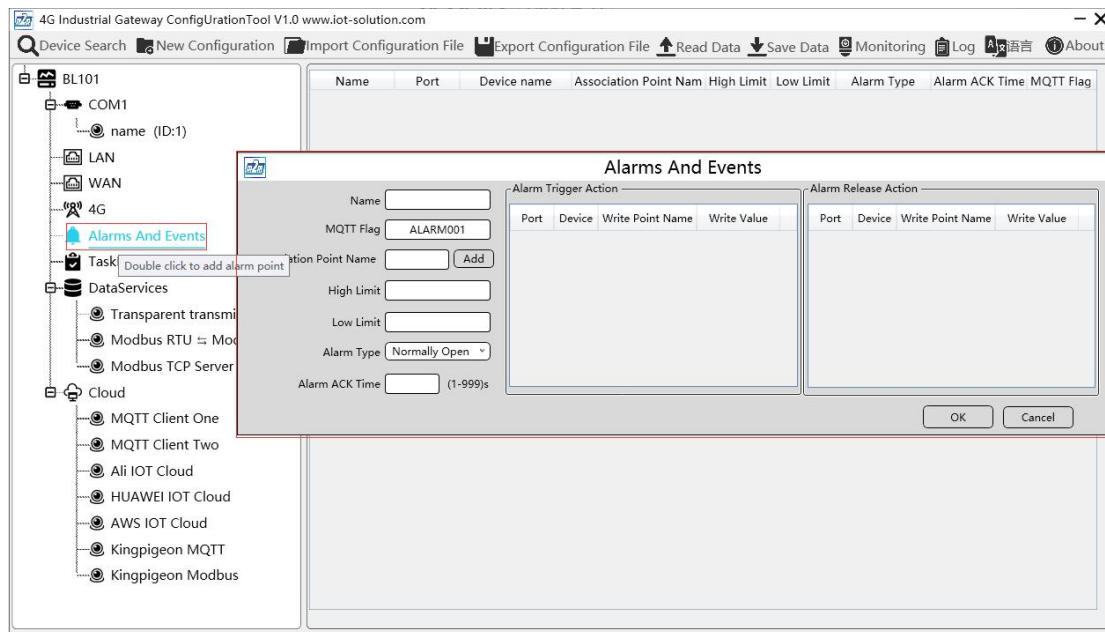

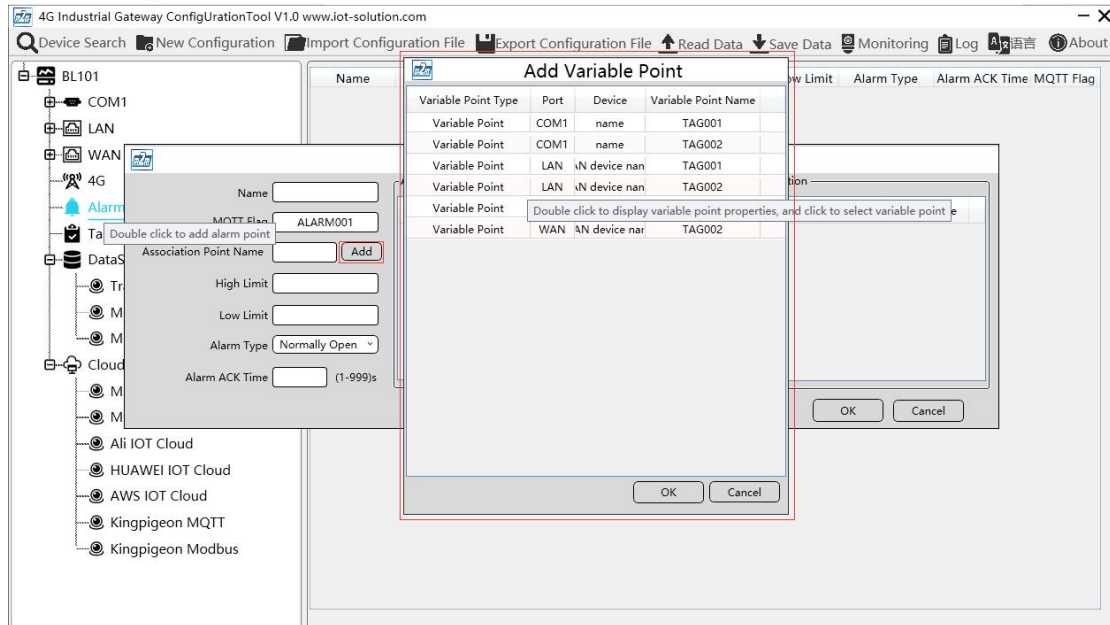

Alarm and Events Configuration

Item	Description
Name	Name of Alarm Point
MQTT Flag	MQTT flag of alarm point, can be randomly set
Association Point Name	Select alarm point and click Add. Datapoint box will pop up. Click the point to be set for alarm and click OK to confirm. Double click datapoint to enter datapoint attribute page
High Limit	High Limit alarm value of numeric datapoints
Low Limit	Low limit alarm value of numeric datapoints
Digital Alarm Type	Select from digital alarm mode: Normally Open or Normally Close
Alarm ACK Time	Within alarm acknowledge time, if data will recover to normal value, no alarm will be triggered. Otherwise it will generate alarm
OK	Confirm alarms and events setting
Cancel	Cancel alarms and events setting

4.2.6.2 Alarm Event Configuration

Right click Alarm Trigger Action box and click Add to enter Event configuration box for setting actions to be performed when alarm is triggered. Right click Alarm Release Action box to set actions to be performed when alarm is released

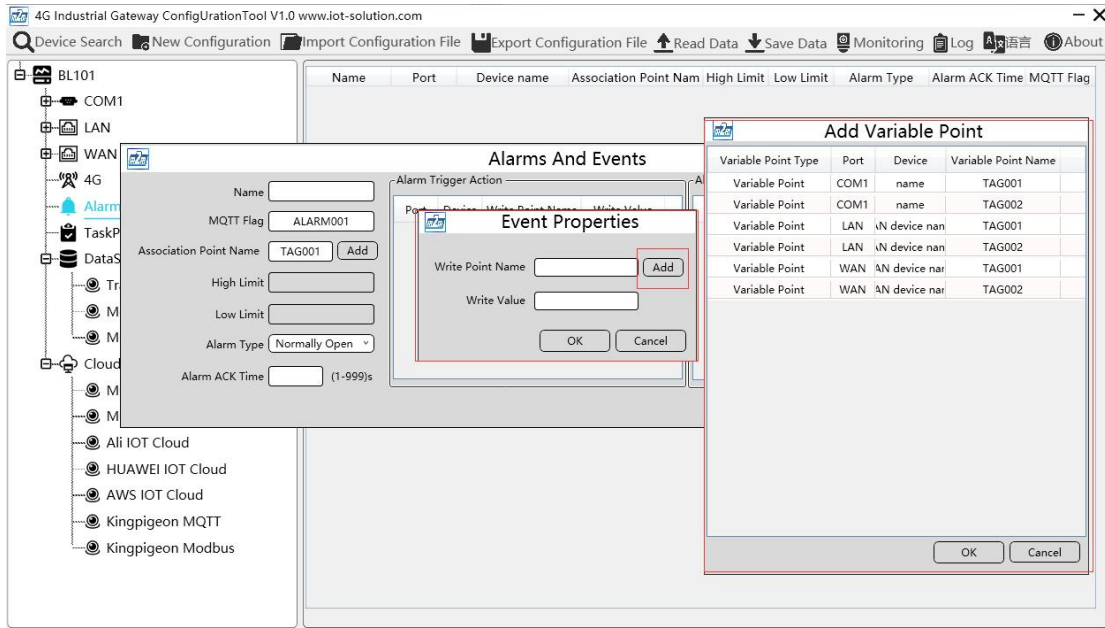
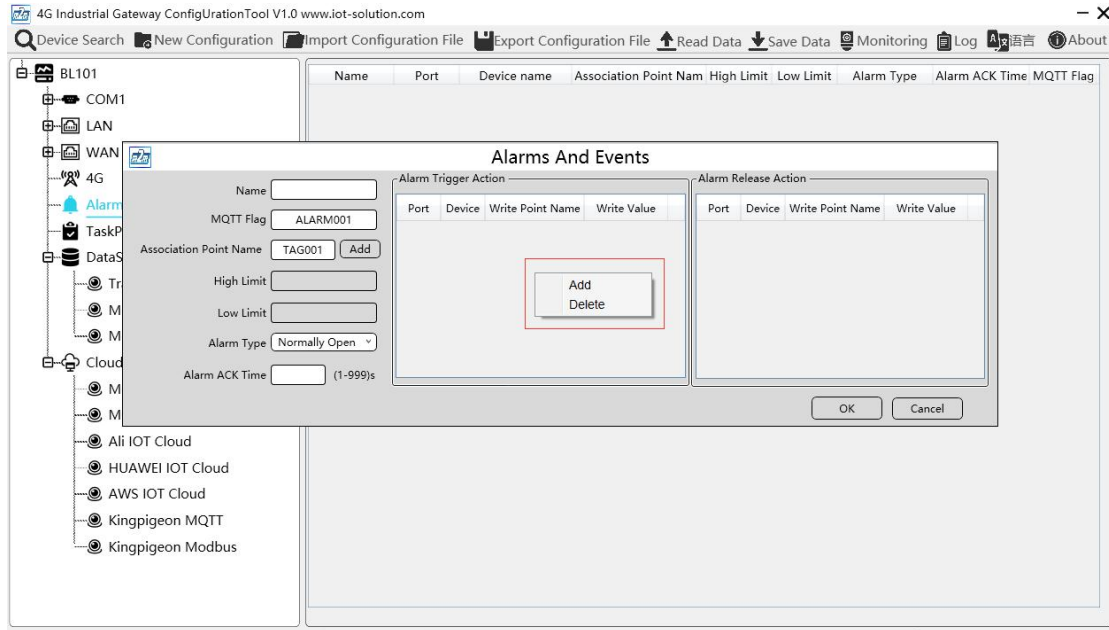

Event Configuration	
Item	Introduction
Write Point Name	Write Point Name is generated based on selected datapoint. Click Add, select datapoint and click OK to confirm. Double click datapoint to view its attributes
Write Value	Write datapoint value. For Boolean value, select 1 or 0

4.2.7 Task Plan Configuration

Double click Task Plan to enter configuration box. Right click the box and click Add to enter configuration box

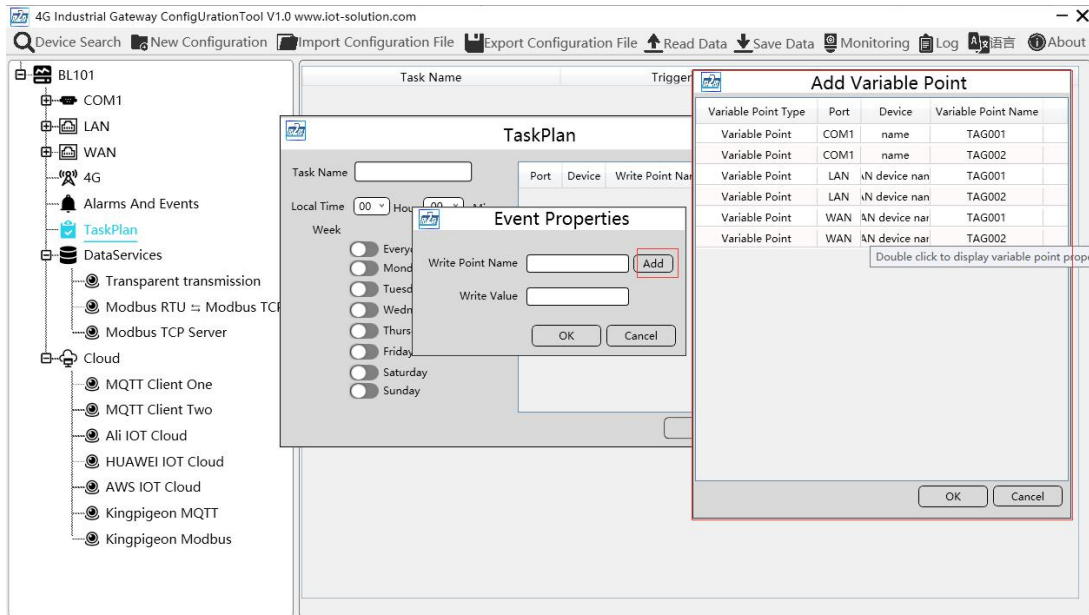
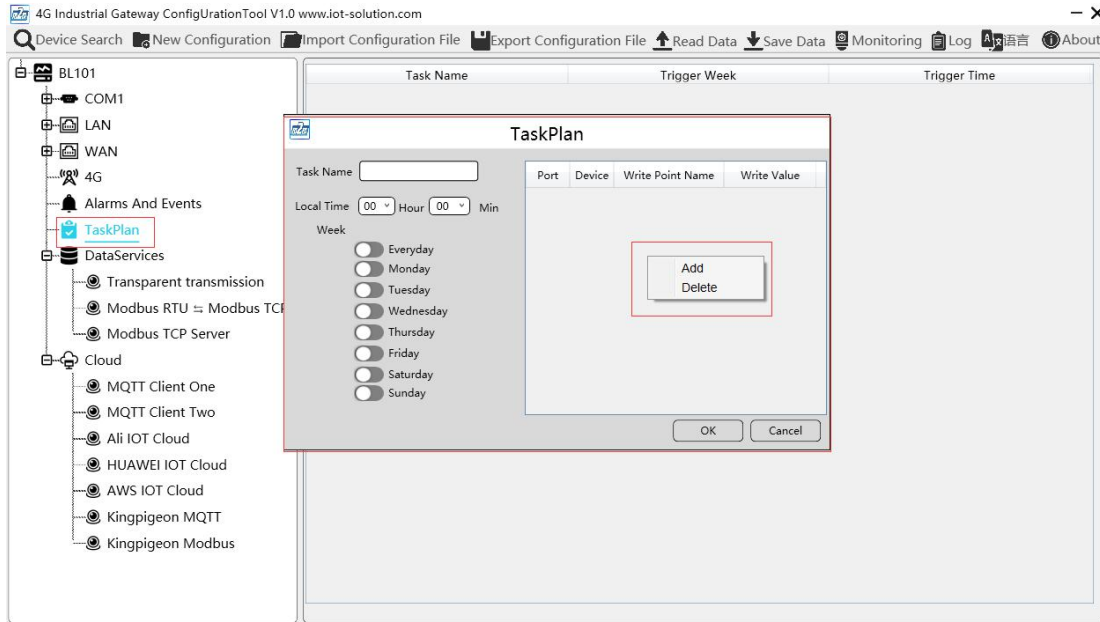

Task Plan Configuration	
Item	Description
Task Name	Name of Task Plan
UTC Time	Set time to perform the planned task (UTC time)
Week	Set week day to perform the planned task
Write Point Name	Write Point Name will be generated based on selected

	datapoint. Click Add, select the datapoint and click OK to confirm. Double click datapoint to view its attributes
Write Value	Write datapoint value. For Boolean value, select 1 or 0
OK	Confirm Task Plan setting
Cancel	Cancel Task Plan setting

4.2.8 Data Service

4.2.8.1 Transparent Transmission

Set COM mode to Transparent Transmission, set COM parameters and then configure Transparent Transmission parameters

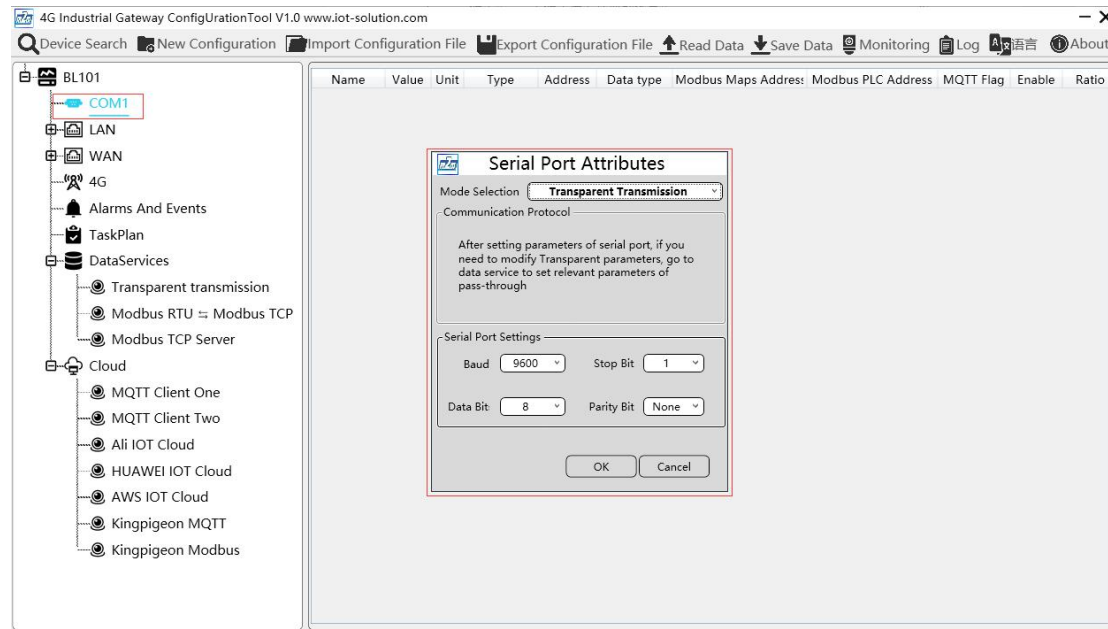

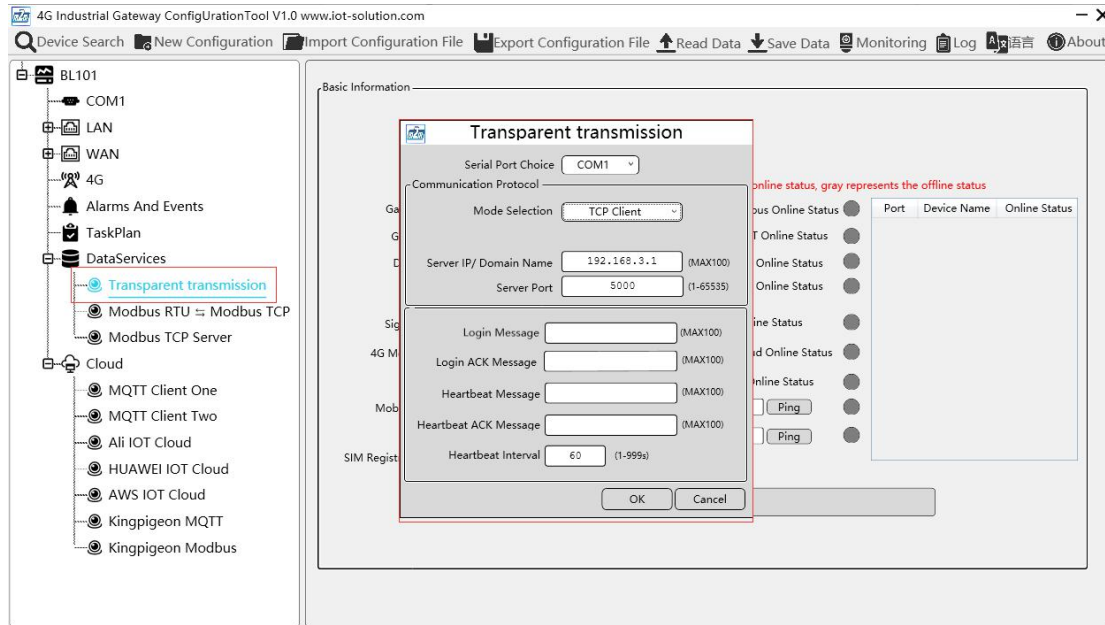

Transparent Transmission Configuration

Item	Description
Serial Port Choice	COM1
Mode Selection	Select Gateway as “TCP Server” or “TCP Client”
Select Network Port	Only set it when BL101 Gateway is used as TCP server Select WAN or LAN
Server IP /Domain Name	If BL101 is used as server, it can't be set but automatically show selected WAN or LAN IP If BL101 is used as client, input transparent transmission server IP
Monitoring Port /Server Port	If BL101 is used as server, input monitoring port If BL101 is used as client, input server port
Login Message	Data Package of logging in to server
Login ACK Message	Data Package of server response to login
Heatbeat Message	Heatbeat Data Package to keep connection
Heatbeat ACK Message	Data Package of server response to heartbeat
Heatbeat Interval	Cycle time of sending heatbeat package. Default is 60s
OK	Confirm Transparent Transmission setting
Cancel	Cancel Transparent Transmission setting

4.2.8.2 Modbus RTU to Modbus TCP

Set COM mode to Modbus RTU to Modbus TCP, set COM parameter and then configure Modbus RTU to Modbus TCP parameters.

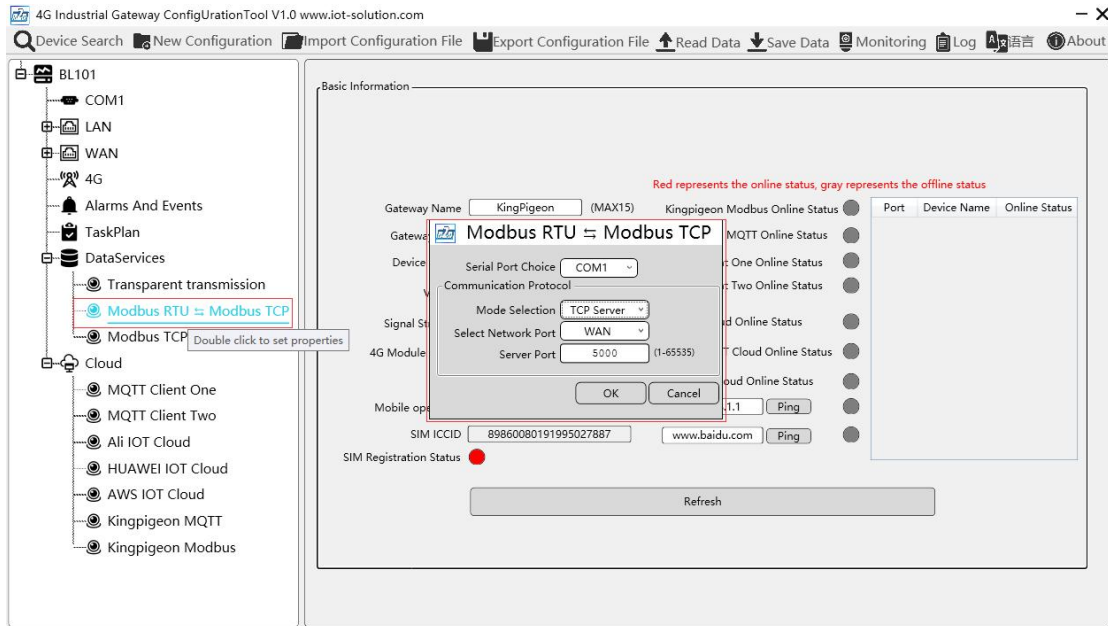
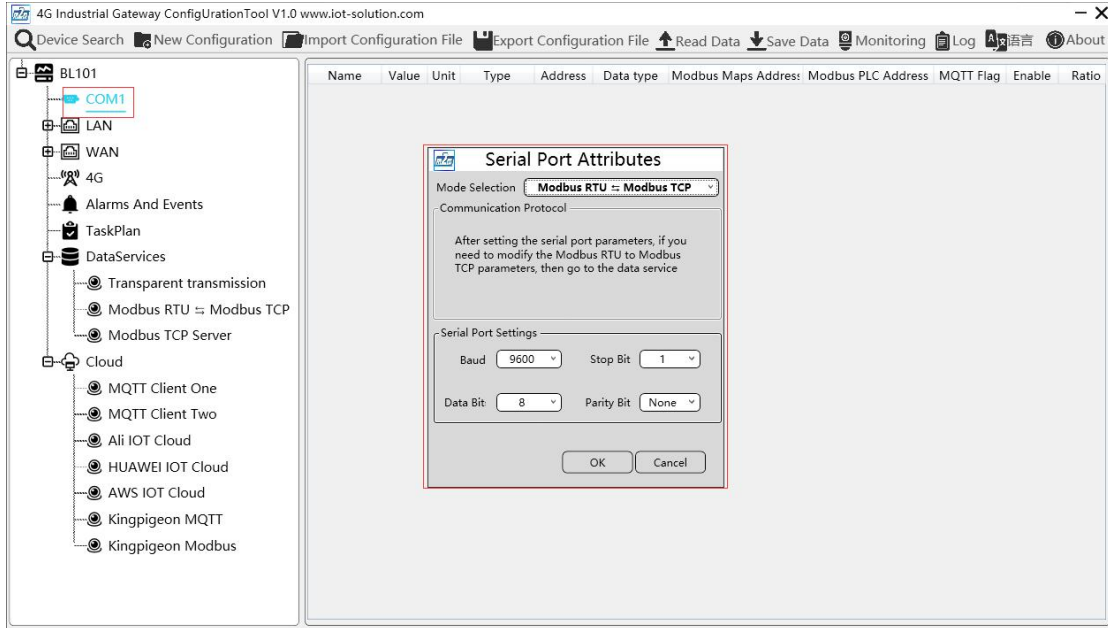

Modbus RTU to Modbus TCP Configuration	
Item	Description
Serial Port Choice	COM1
Mode Selection	TCP Server (Gateway can only be TCP Server)
Select Network Port	Select "WAN" or "LAN"
Monitoring Port	Input port of monitoring BL101 Gateway (required)
OK	Confirm Modbus RTU to Modbus TCP configuration
Cancel	Cancel Modbus RTU to Modbus TCP configuration

4.2.8.3 Modbus TCP Server

BL101 Gateway supports Modbus TCP protocol and provides data as Modbus TCP server. Modbus TCP server is enabled permanently. Only configure Ethernet port and monitoring port

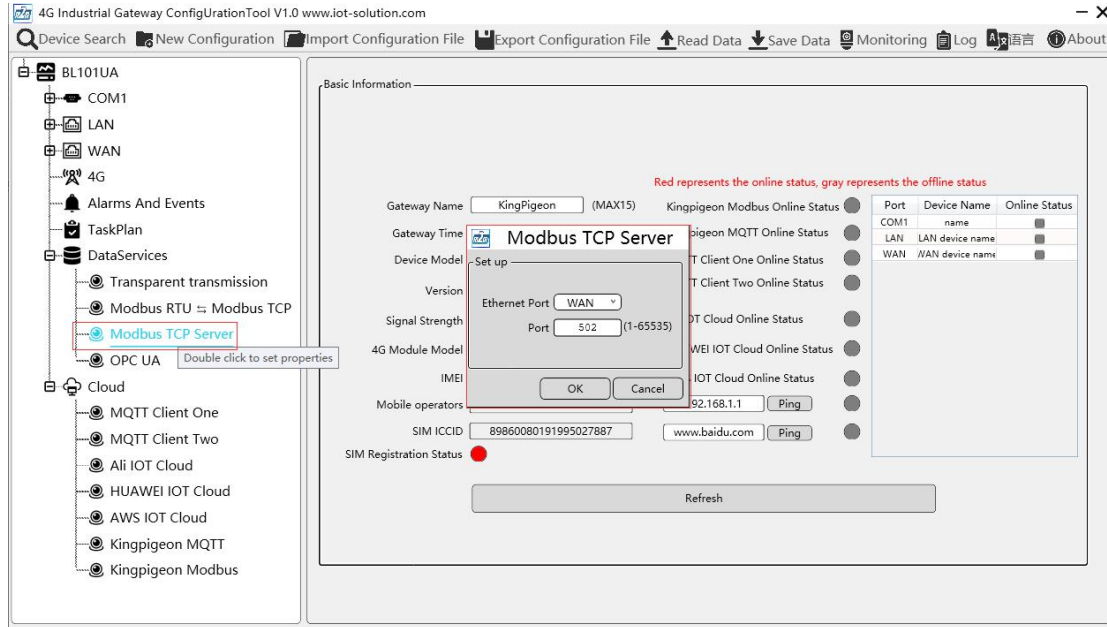

Modbus TCP Server Configuration	
Item	Description
Ethernet Port	Select "WAN" or "LAN"
Port	Input gateway monitoring port (required)
OK	Confirm Modbus TCP Server setting
Cancel	Cancel Modbus TCP Server setting

4.2.8.4 OPC UA

BL101 Gateway supports OPC UA protocol and provides data as OPC UA server

Note: Only the model which supports OPC UA needs this configuration

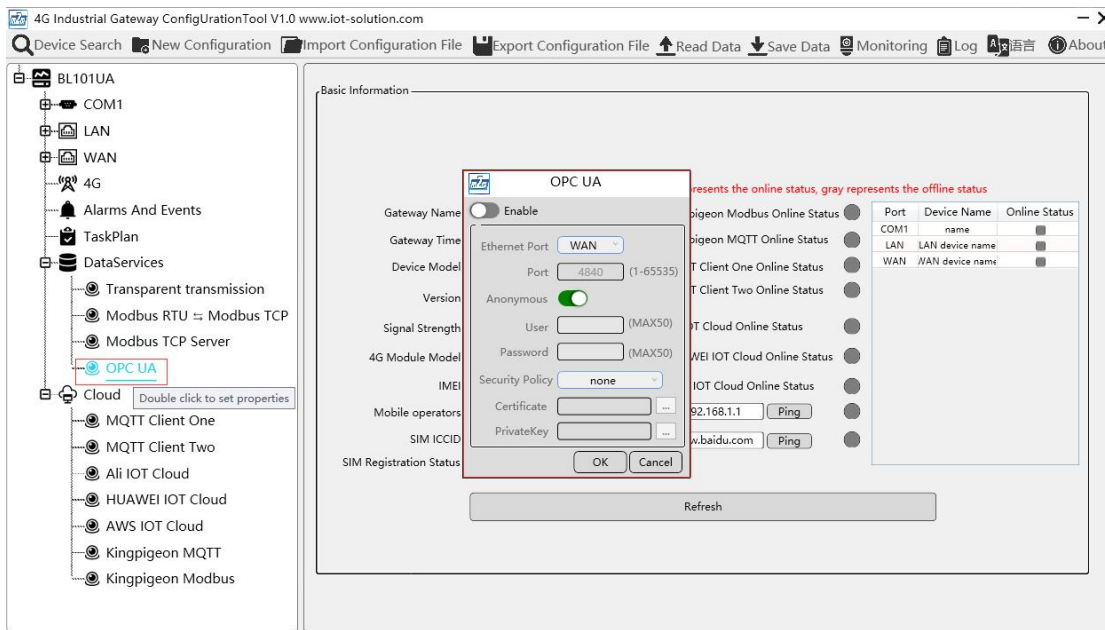

OPC UA Configuration	
Item	Description
Enable	Green indicates OPC UA is enabled Gray indicates OPC UA is disabled. Default is disabled
Ethernet Port	Select "WAN" or "LAN"
Port	Input server port (required)
Anonymous	Green indicates login anonymously. Default is Green. Gray indicates login with Account and Password.
User	Input User Name
Password	Input User Password
Security Policy	Encryption policy. Select "none", "basic256", "basic128rsa15" or "basic256sha256"
Certificate	OPC UA certificate, select file to upload
PrivateKey	OPC UA encryption key, select file to upload
OK	Confirm OPC UA setting
Cancel	Cancel OPC UA setting

4.2.9 Cloud Platform Connection

BL101 Gateway supports device online in multiple cloud platforms simultaneously.

4.2.9.1 MQTT Client One

MQTT Client One can be connected to cloud with certificate or without certificate

It supports multiple publishing topics.

Click Add to set publish topic. Publish topic name can be viewed from drop-down list of Publish Topic. Select Publish Topic Name and click Delete to delete publish topic. MQTT Client One supports publishing certain datapoints of each topic. Move mouse cursor to the right box, right click it and click Add to enter datapoint dialog box. Select the datapoint to publish and click OK to confirm it. Double click datapoint to view its attributes.

Take below picture for example, only datapoint TAG001 of COM Device 1 is published and other datapoints are not published.

Note: Datapoint box is blank in default which means all datapoints will be published in default. If multiple topics are published, only one topic datapoint box can be blank. Other topic datapoints must be selected.

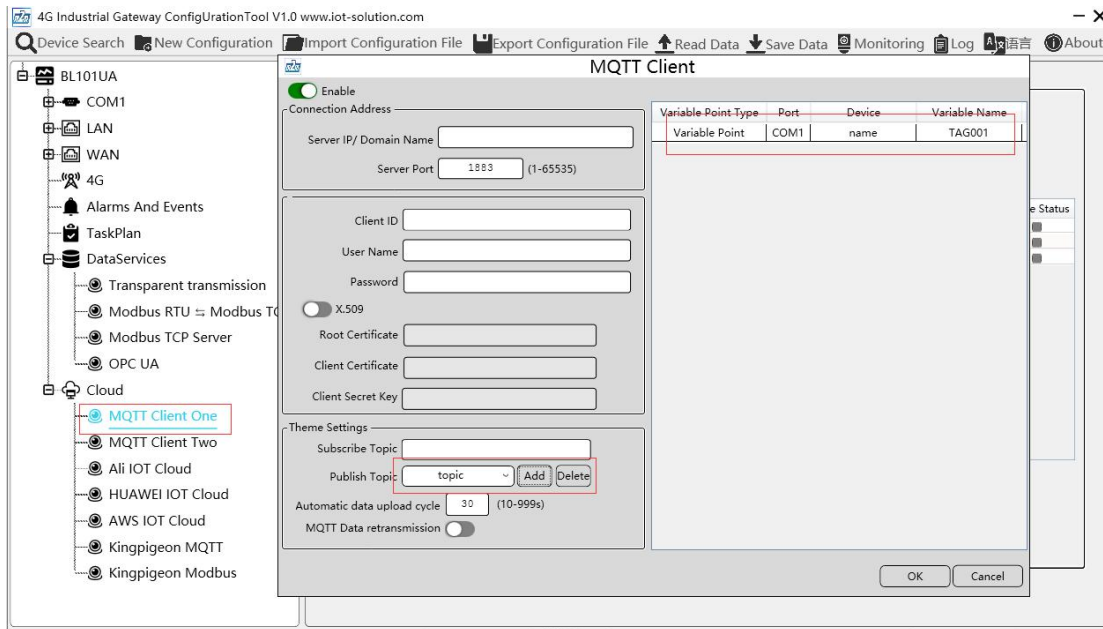

MQTT Client One Configuration

Item	Description
Enable	Green indicates MQTT Client One is enabled Gray indicates MQTT Client One is not enabled.
Server IP/ Domain Name	Input Server IP/Domain name
Server Port	Input server port(required), default is 1883
Client ID	Client Identifier of MQTT Connecting message. Server uses it to identify Client
User Name	User Name of MQTT Connecting message. Server uses it for ID verification and authorization
Password	Password of MQTT Connecting message Server uses it for ID verification and authorization



X.509 (Enable Certificate)	Green indicates certificate is enabled Gray indicates certificate is not enabled
Root Certificate	Select file to upload (Need enable Certificate first)
Client Certificate	Select file to upload (Need enable Certificate first)
Client Private Key	Select file to upload (Need enable Certificate first)
Subscribe Topic	Topic of MQTT subscribing message. After subscribing server can send message to client for controlling
Publish Topic	Topic of MQTT publishing message. It's used for MQTT to identify message channel of sending valid load data. Wildcard can't be included in publishing message topic name. Click Add to add more public topics. Click Delete to delete Public Topic
Uploading Interval	Cycle time of MQTT data sending. Default is 30s
MQTT Data Re-transmission (Enable data re-transmission)	Green indicates offline data will be transmitted once network recovers; Gray indicates offline data will not be transmitted once network resumes
OK	Confirm MQTT Client One setting
Cancel	Cancel MQTT Client One setting

4.2.9.2 MQTT Client Two

Follow the same procedure of configuring MQTT Client One to set MQTT Client Two MQTT Client Two subscribe topic does not work. MQTT Client Two is used for viewing data from cloud but not controlling data

MQTT Client Two Configuration refer to [MQTT Client One](#)

4.2.9.3 Alibaba Cloud

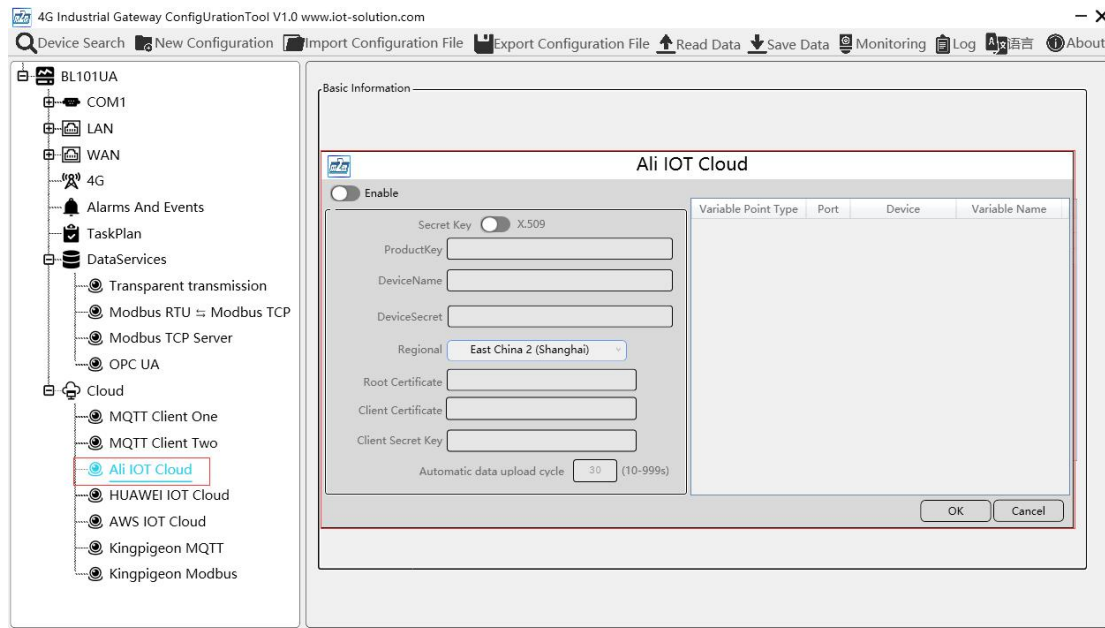

Alibaba Cloud Configuration	
Item	Description
Enable	Green indicates Alibaba Cloud is enabled Gray indicates Alibaba Cloud is not enabled. Default is disabled
Secret Key/X.509	Default is connecting with Secret Key. Click it to move the button on the right for connecting with Certificate.
ProductKey	Set the same ProductKey as the one in Ali Cloud. See below illustration (Device-Click DeviceSecret to view it)
DeviceName	Set the same DeviceName as the one in Ali Cloud See below illustration (Device-Click DeviceSecret to view it)
DeviceSecret	Set the same DeviceSecret as the one in Ali Cloud See below illustration (Device-Click DeviceSecret to view it)
Region	Select Alibaba Cloud Region, default is East China 2(Shanghai)
Root Certificate	Select file to upload (Need to select certificate X.509 first)
Client Certificate	Select file to upload (Need to select certificate X.509 first)
Client Secret Key	Select file to upload (Need to select certificate X.509 first)
Automatic Data Upload Cycle	Cycle time of data sending. Default is 30s
Publish Datapoint Selection	Default is blank box with all datapoints to be uploaded Right click the box and click Add to select datapoint for uploading. Click OK to confirm it.

OK	Confirm Alibaba Cloud setting
Cancel	Cancel Alibaba Cloud setting

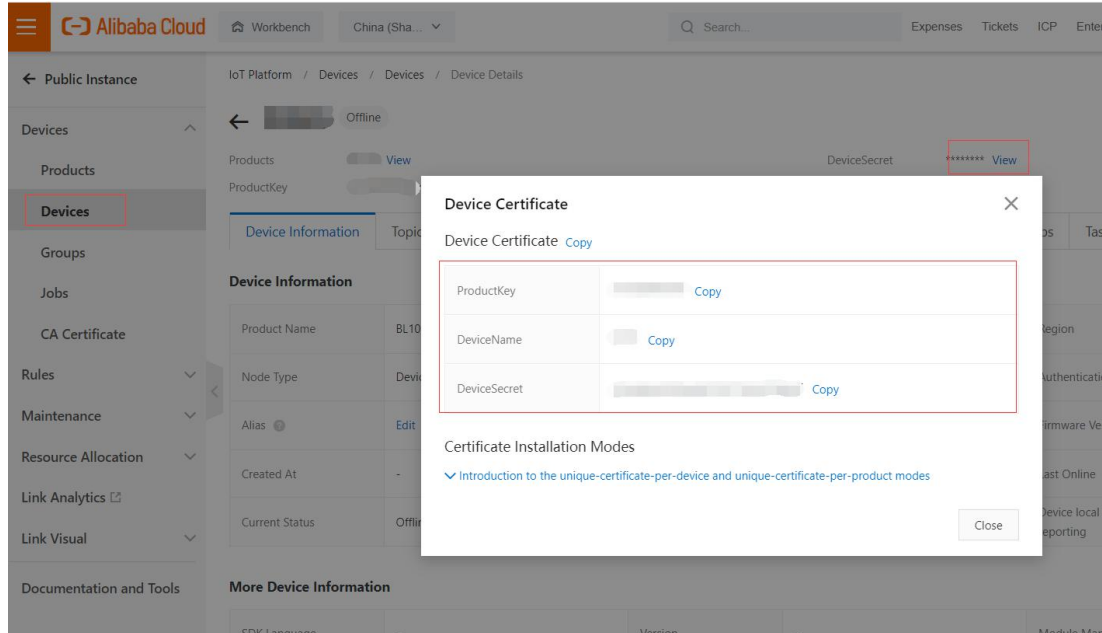

4.2.9.4 HUAWEI Cloud

HUAWEI Cloud can be connected with or without Certificate. It supports multiple service IDs. Click Add to set Service ID. ID can be viewed from the drop-down list. Click Delete to delete service ID.

HUAWEI Cloud supports uploading certain datapoints of each Service ID. Right click the box and click Add to enter datapoint dialog box. Select the datapoint to upload and click OK to confirm it. Double click the datapoint to view its attributes.

Note: Datapoint box is blank in default which means all datapoints will be uploaded. If there're multiple Service IDs, only one Service ID datapoint box can be blank. Datapoints for uploading must be selected for other Service IDs.

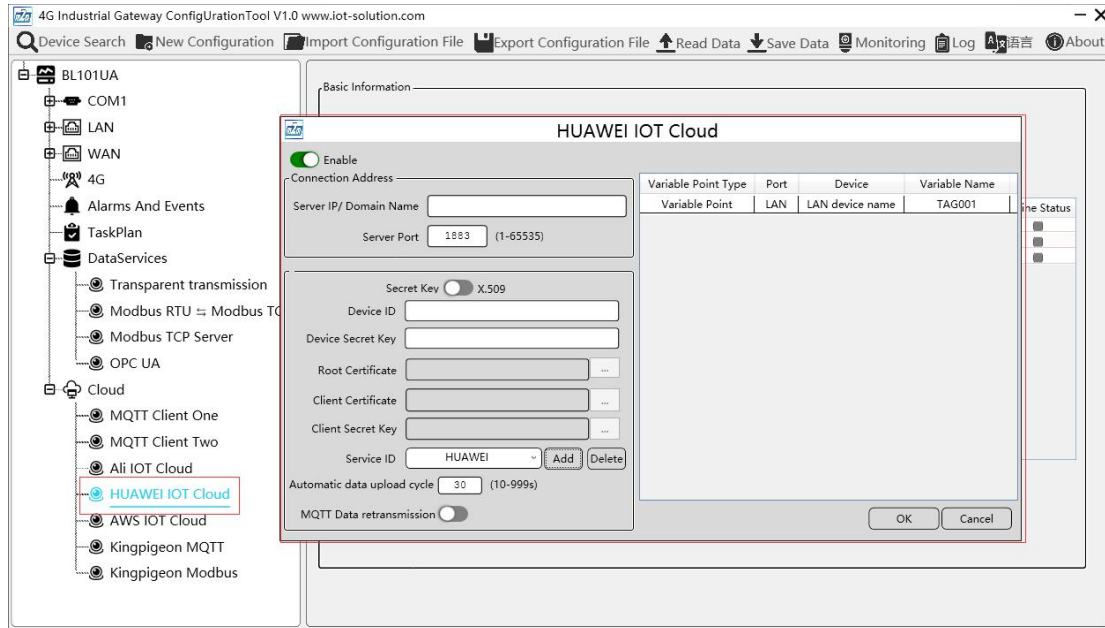

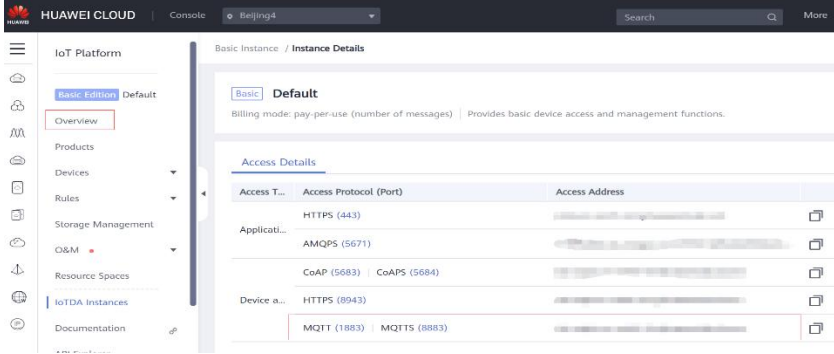
HUAWEI Cloud Configuration	
Item	Description
Enable	Green indicates HUAWEI Cloud is enabled. Gray indicates HUAWEI Cloud is disabled. Default is disabled
Server IP/ Domain Name	Select connecting to HUAWEI Cloud via MQTT to enter console. Click Overview to get server IP address of device connection 
Server Port	Default is 1883, input 1883 for connecting with Secret Key Input 8883 for connecting with Certificate (Required)
Secret Key/X.509	Default is connecting with Secret Key. Click it to move the button on the right for connecting with Certificate
Device ID	Set the same ID as the one in HUAWEI Cloud(Device-Device ID)

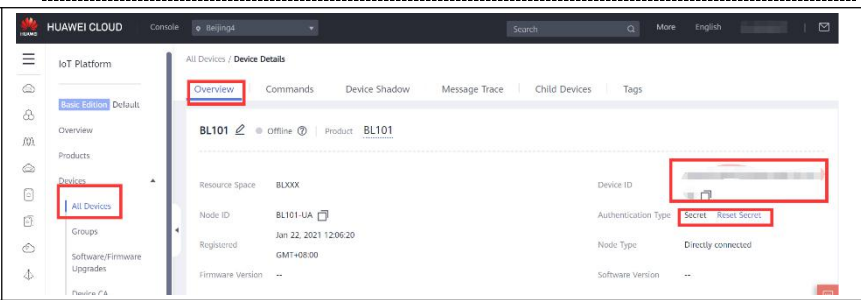
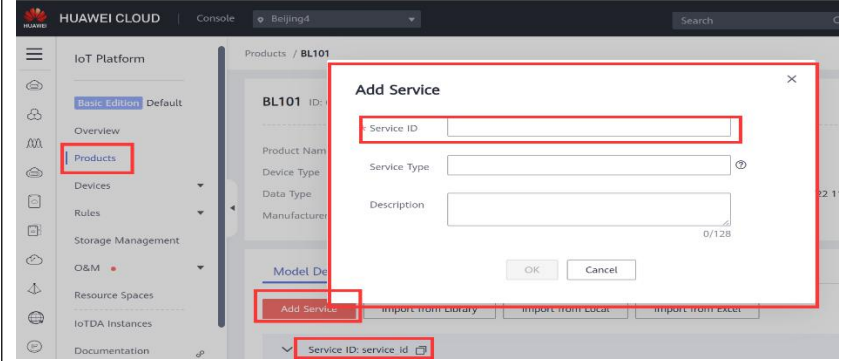
	
<p>Device Secret Key</p>	<p>Set the same Device Secret Key as the one in HUAWEI Cloud when creating device in HUAWEI Cloud. If it's forgot, it can be reset in device authentication. (Not necessary if connecting with certificate is selected)</p>
<p>Root Certificate</p>	<p>Select file to upload (Need to select certificate X.509 first)</p>
<p>Client Certificate</p>	<p>Select file to upload (Need to select certificate X.509 first)</p>
<p>Client Secret Key</p>	<p>Select file to upload (Need to select certificate X.509 first)</p>
<p>Service ID</p>	<p>Set the same Service ID as the one in HUAWEI Cloud. (IOT Platform-Products-Add Service-Service ID)</p>  <p>Multiple Service IDs are supported</p>
<p>Automatic Data Upload Cycle</p>	<p>Cycle time of data uploading. Default is 30s</p>
<p>MQTT Data Re-transmission</p>	<p>Green indicates offline data will be transmitted once network recovers; Gray indicates offline data will not be transmitted once network resumes</p>
<p>Datapoint Uploading Selection</p>	<p>Default is blank box with all datapoints to be uploaded Right click the box and click Add to select datapoint for uploading. Click OK to confirm it.</p>
<p>OK</p>	<p>Confirm HUAWEI Cloud setting</p>
<p>Cancel</p>	<p>Cancel HUWEI Cloud setting</p>

4.2.9.5 AWS (Amazon Web Service)

Note: Datapoint box is blank in default which means all datapoints will be published. If

multiple topics are published, only one topic datapoint box can be blank. For other topics, datapoints for publishing must be selected.

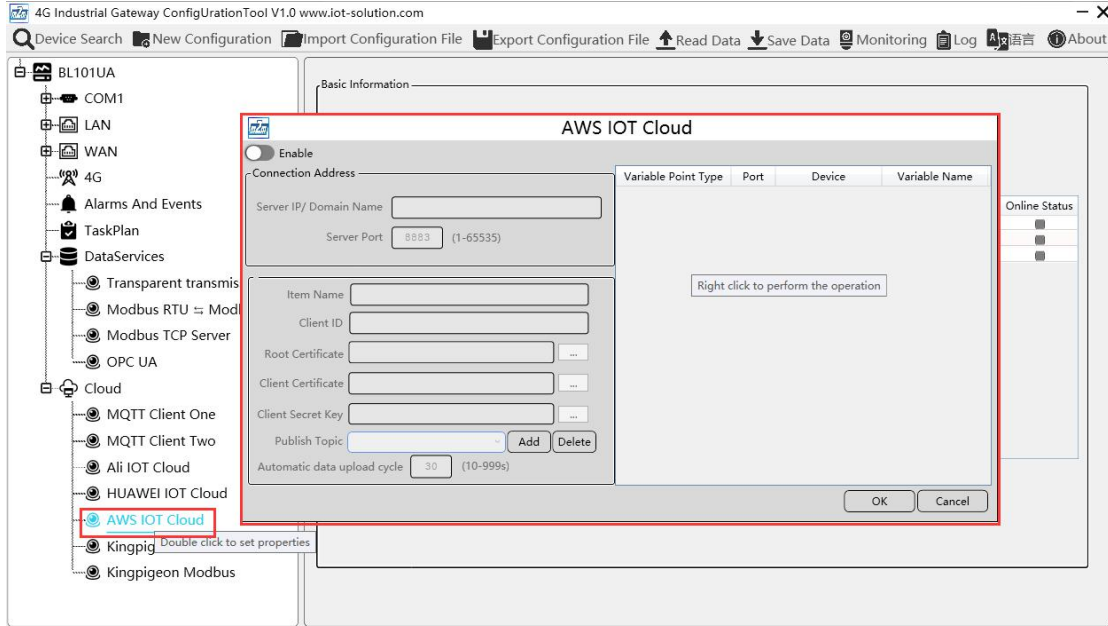

AWS Configuration	
Item	Description
Enable	Green indicates AWS is enabled. Gray indicates AWS is disabled. Default is disabled
Server IP/ Domain Name	Input ASW Connection Endpoint (Enter Console, click Things and then click Interact to get it)
Server Port	8883 (Required)
Item Name	Input Thing ARN

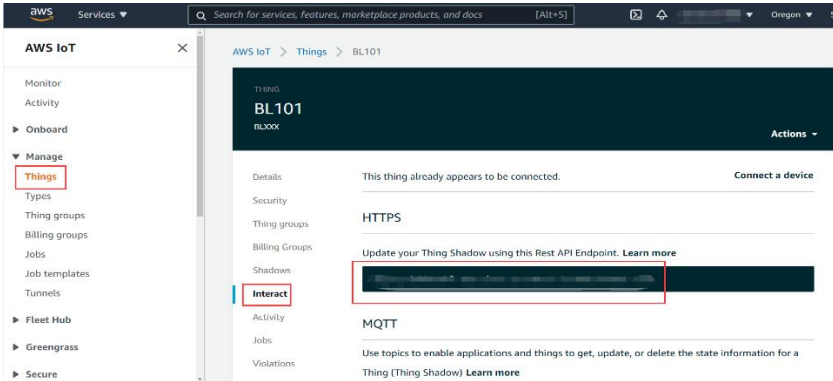



Modbus to MQTT IoT Gateway

-BL101

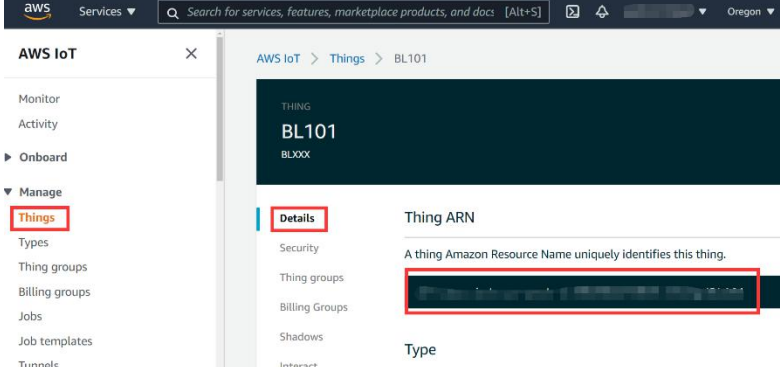
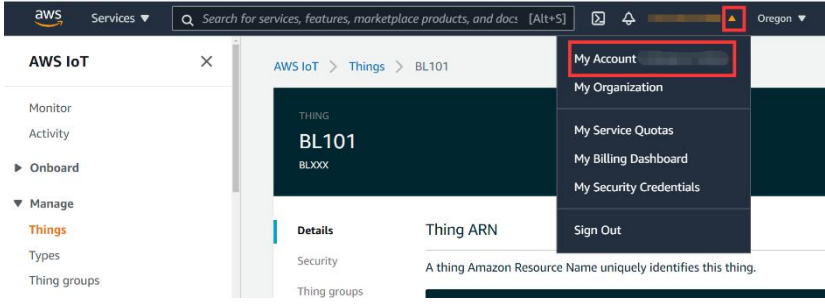
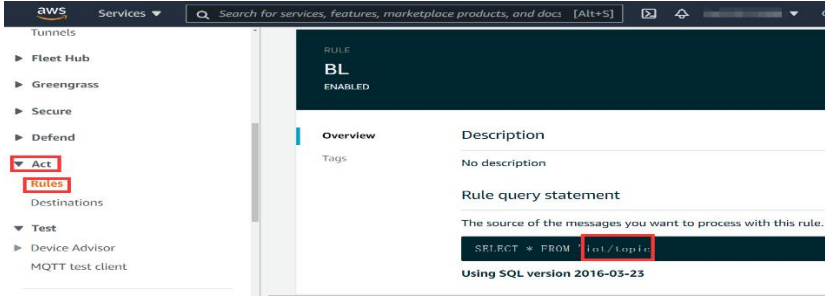
	
Client ID	<p>Input AWS Account ID</p> 
Root Certificate	Select file to upload it
Client Certificate	Select file to upload it
Client Secret Key	Select file to upload it
Publish Topic	<p>Input the same topic when creating rules in AWS cloud. It's the topic used for MQTT publishing message.</p> <p>Click Add to create more Publish Topics. Select Publish Topic and click Delete to delete it.</p> 
Automatic Data Upload Cycle	Cycle time of data uploading. Default is 30s
Datapoint Publishing Selection	Default is blank box with all datapoints to be published Right click the box and click Add to select datapoint for publishing. Click OK to confirm it. .
OK	Confirm AWS setting
Cancel	Cancel AWS setting



4.2.9.6 King Pigeon Cloud via MQTT

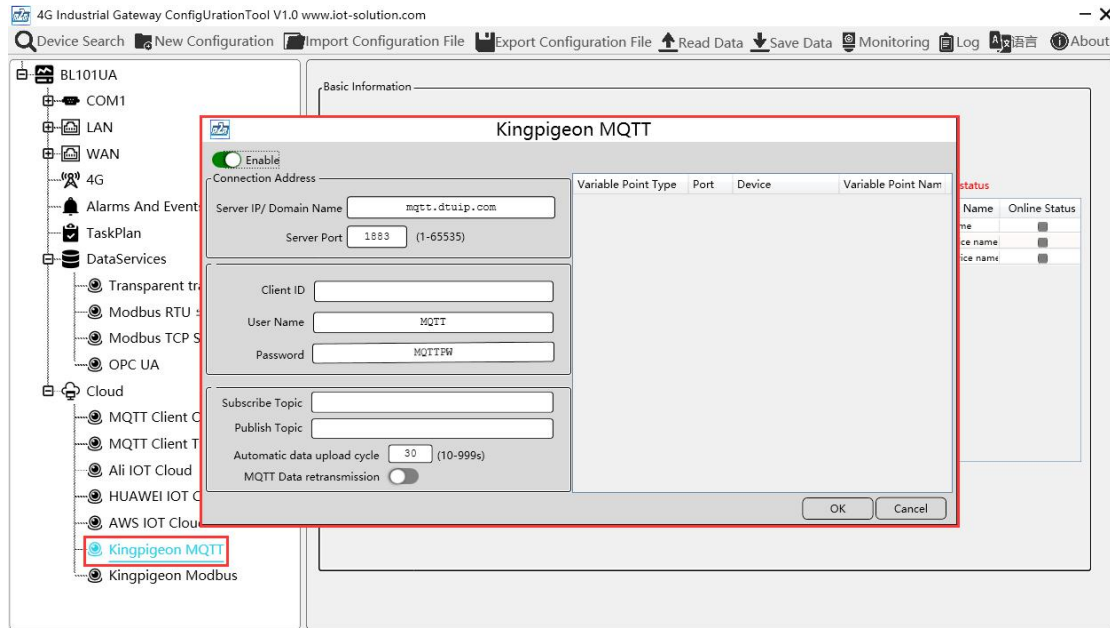

King Pigeon Cloud via MQTT Configuration	
Item	Description
Enable	Green indicates King Pigeon cloud via MQTT is enabled Gray indicates King Pigeon cloud via MQTT is disabled
Server IP/Domain Name	mqtt.dtuip.com
Server Port	1883(Required)
Client ID	Input device serial number issued by King Pigeon (Contact King Pigeon sales to get the serial number if required to connect to King Pigeon cloud)
User Name	MQTT
Password	MQTTPW
Subscribe Topic	King Pigeon Device Serial Number/+
Publish Topic	King Pigeon Device Serial Number
Automatic Data Upload Cycle	Cycle time of data uploading. Default is 30s
MQTT Data Retransmission	Green indicates offline data will be transmitted once network recovers; Gray indicates offline data will not be transmitted once network resumes
Publishing Datapoint Selection	Default is blank box with all datapoints to be published Right click the box and click Add to select datapoint for publishing. Click OK to confirm it.



OK	Confirm King Pigeon Cloud via MQTT setting
Cancel	Cancel King Pigeon Cloud via MQTT setting

4.2.9.7 King Pigeon Cloud via Modbus

Both King Pigeon Cloud and customized Clouds can be connected via Modbus RTU protocol.

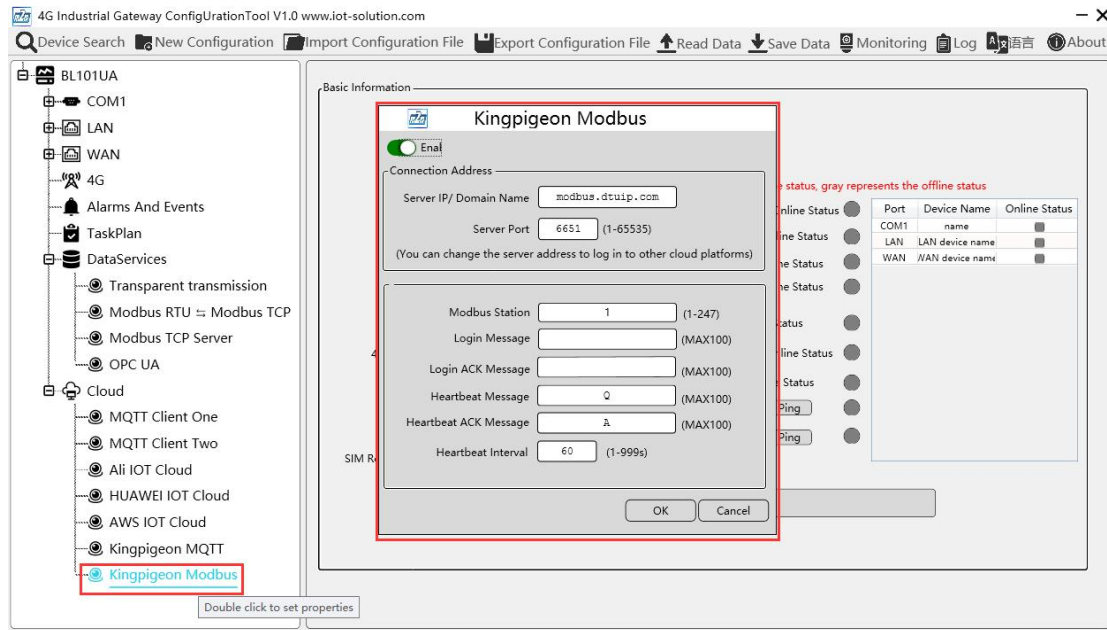

King Pigeon Cloud via Modbus	
Item	Description
Enable	Green indicates King Pigeon Cloud via Modbus is enabled Gray indicates King Pigeon Cloud via Modbus is disabled
Server IP/Domain Name	modbus.dtuip.com
Server Port	6651 (Required)
Modbus Station/ID	Set Modbus communication address of this Gateway device
Login Message	Input device serial number issued by King Pigeon (Contact King Pigeon sales to get the serial number)
Login ACK Message	Server acknowledges login messages (Not necessary for King Pigeon Cloud)
Heatbeat Message	Q (Heatbeat message to keep connection)
Heatbeat ACK Message	A (Server acknowledges heatbeat messages)
Heatbeat Interval	Cycle time of sending Heatbeat messages, default is 60s
OK	Confirm King Pigeon Cloud via Modbus setting
Cancel	Cancel King Pigeon Cloud via Modbus setting

5 BL101 Gateway Application Example

BL101 COM port connects remote IO module M140T and collects its data through Modbus RTU protocol.

BL101 LAN port connects network switch N81 and multi-functional RTU S475 connects N81 switch. S475 data is collected through Modbus TCP protocol.

BL101 WAN port connects 4G industrial Router R40 LAN port. Router R40 provides network to BL101 Gateway. The collected data is uploaded to various cloud platforms

5.1 Device Connecting Diagram

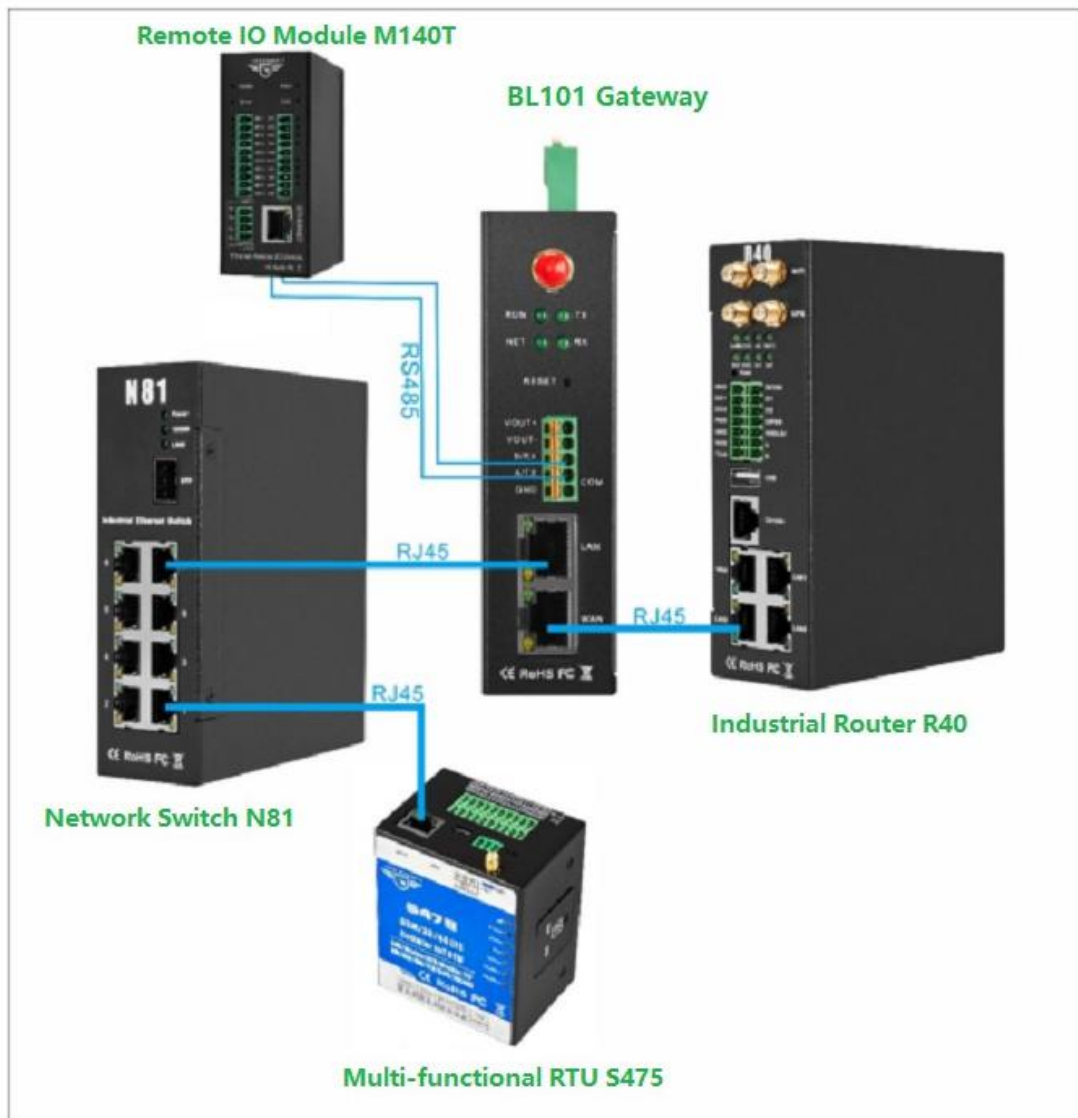

5.2 Configuration Software Setting

Connecting devices, datapoints and cloud connection must be set in configuration software

5.2.1 Add Devices and Datapoints

5.2.1.1 COM Port Configuration

COM port collects M140 data through Modbus RTU. Configure COM port like below

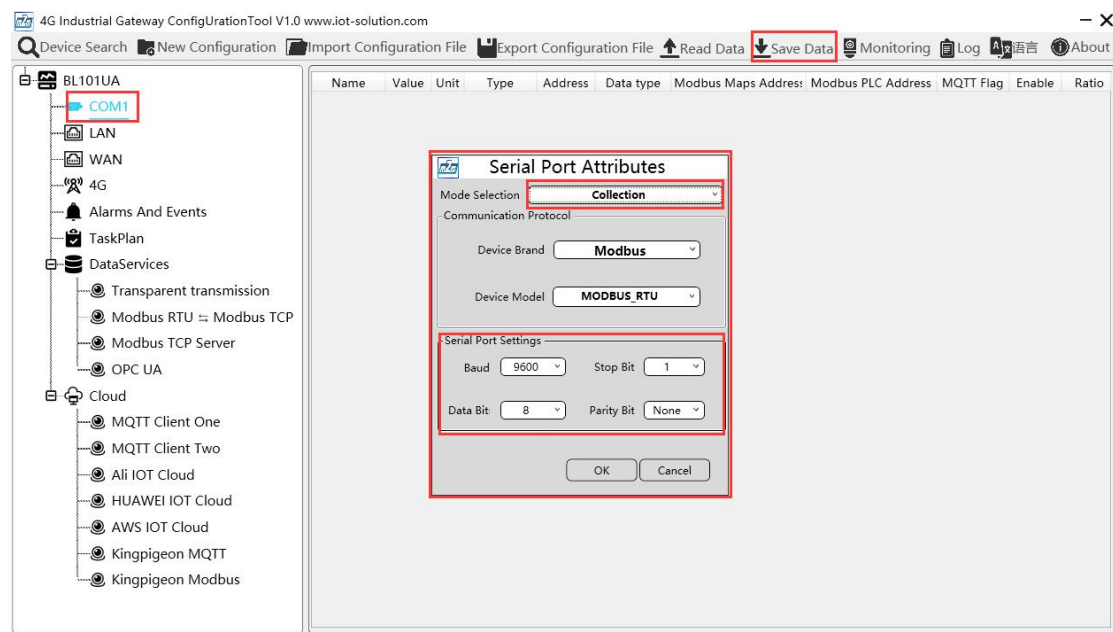

- (1) Double click "COM1" to enter configuration window
- (2) Mode Selection: Collection
- (3) Device Brand: Modbus; Device Model: Modbus RTU
- (4) Baud rate, Stop bit, Data Bit and Parity Bit will be set the same as that in M140T RS485 port
- (5) Click OK to confirm

Note: Click Save Data. Gateway will restart automatically. COM configuration will be valid after device restarting

5.2.1.2 Add M140T to COM Port

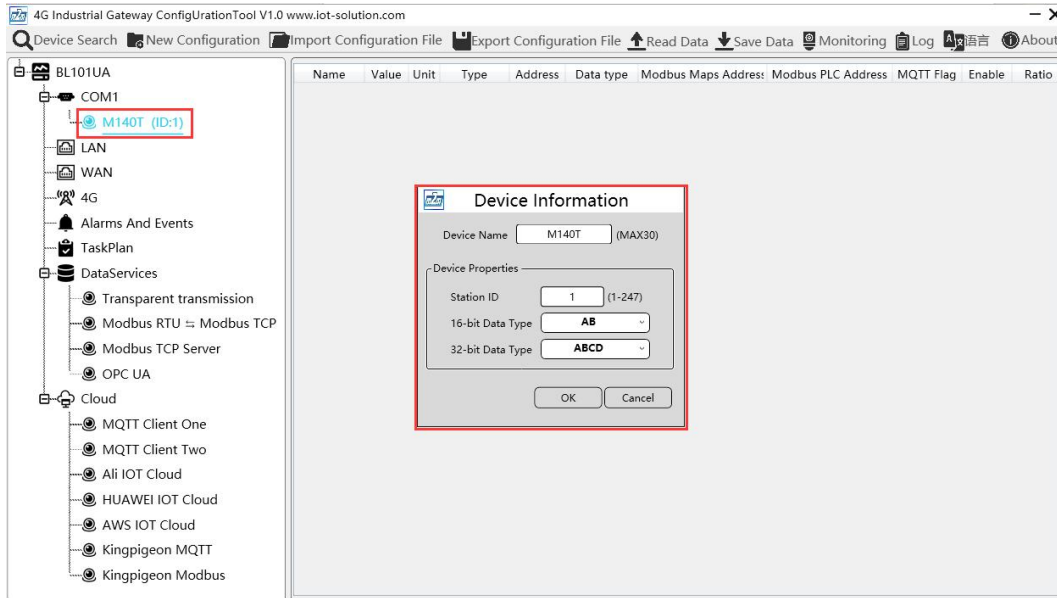

- (1) Click COM1, right click the mouse and click Add to enter configuration box
- (2) Set device name, for example, set M140T as device name
- (3) Input device modbus address, for example, if M140T Modbus ID is 1, put 1
- (4) Select Type of data to be collected.
- (5) Click OK to confirm adding M140T
- (6) Click COM1 to view the added device M140T. If more devices to be added, perform the same procedures as above Step (1)-(5)

Note: Click Save Data. Gateway BL101 will restart automatically. After restarting, M140T is added successfully.

5.2.1.3 Add M140T Datapoints

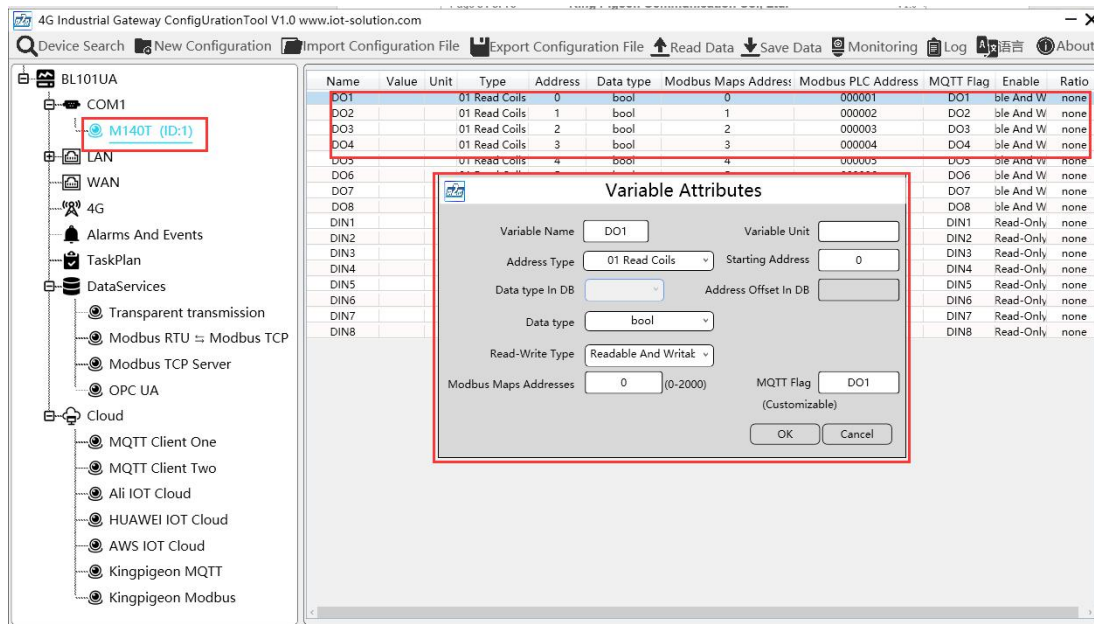

- (1) Click M140T, move mouse cursor to the right box, right click mouse to enter datapoint configuration window
- (2) Set datapoint name, for example, DO1
- (3) Address Type: Select the address type to be supported by the function code of datapoint, for example, select 01 reading holding coil for M140T DO as it supports function code 01; select 02 read input coil for M140T DI as it supports function code 02
- (4) Data Type: Select datapoint data type. For example, select bool for M140T DI & DO as both are coil type.
- (5) Read-write Type: Automatic identifying read-write type according to Address Type
- (6) Variable Unit: Input any required unit
- (7) Starting Address: Input datapoint register address, for example, DO1 register address in M140T is 0, input 0
- (8) Adding Qty: if consecutive addresses are collected, the same function code can multiply be collected
- (9) Modbus Mapping Address: Input the address where the collected datapoint is saved in BL101. It can be any address from 0-2000 but can't be repeated. For example, DO1 data is saved in register address 0 of BL101
- (10) MQTT Flag: can be any identification mark, but can't be repeated
- (11) Click OK to confirm

Note: After clicking OK to confirm the configuration, datapoints will appear in the box like above picture. If more datapoints to be added, right click the box and click Add to

enter datapoint configuration box, repeat Step (2)-(11)

Note: Click Save Data. Gateway will restart automatically. After restarting, M140T datapoints are added successfully

5.2.1.4 LAN Port Configuration

Note: Both WAN and LAN can collecting data from devices. Below example is the configuration of adding device S475 in LAN port. WAN port device configuration procedures are the same.

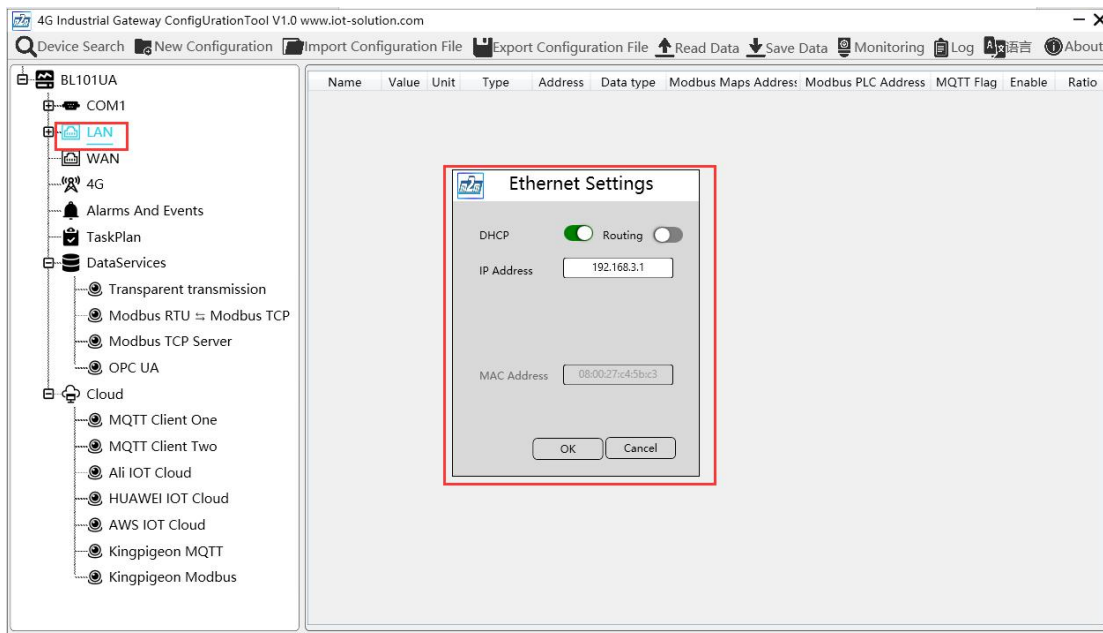

- (1) Double click LAN to enter configuration box
- (2) DHCP: enable auto IP distribution. Default is disabled. For examples, S475 has been set to auto retrieving IP, then LAN port must enable DHCP.
- (3) Routing: Enable network routing function. Default is disabled. For example, S475 data will be collected without network requirement, then disable routing function
- (4) IP Address: default is 192.168.3.1, the IP addresses assigned to LAN port devices must be within the range. It can be changed according to requirement. For example, S475 is set to auto retrieving IP and the range is not limited, thus it's not necessary to change it.
- (5) MAC Address: Input LAN port MAC address
- (6) Click OK to confirm it

Note: Click Save Data and Gateway will restart. Turn off the power of Gateway and restart it. After that LAN port configuration is done successfully

Note: LAN Port IP Address specifies the IP address arrange of LAN port device. If device IP address is not within the range, data can't be collected. Thus it's necessary

to change LAN port IP address according to requirement. IP Address change will not be effective until gateway is power off and powered on again

5.2.1.5 Add LAN Port Device S475

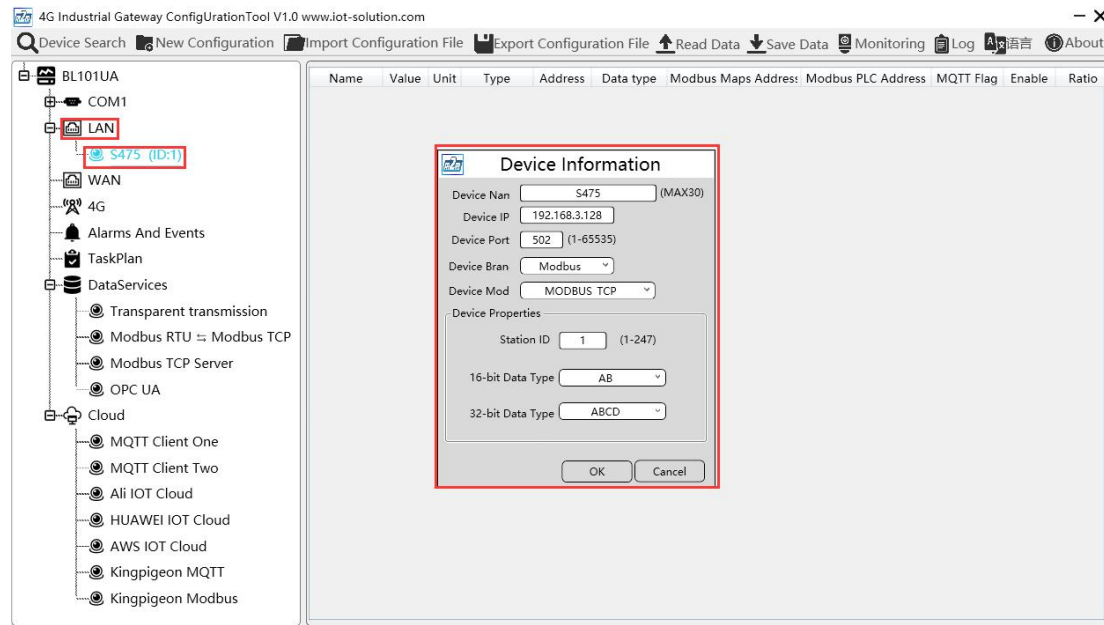

- (1) Click LAN and right click mouse to enter device configuration box
- (2) Device Name: input the name of device to be added, S475
- (3) Device IP: input S475 IP address. For example, S475 is set to auto retrieving IP. Open S475 configuration software and view its IP(192.168.3.125). Thus input S475 IP 192.168.3.125.
- (4) Device Port: input LAN port device port. For example, S475 Modbus TCP port is 502. Thus put 502
- (5) Device Brand: Modbus; Device Model: Modbus TCP
(BL101 collects S475 through LAN port through Modbus TCP protocol)
- (6) Station ID: 1, (S475 Modbus ID is 1)
- (7) Select Data Type. For example, S475 power source and temperature & humidity data is 16-bit AB type, 32-bit data is not collected. Thus select 16-bit AB type and keep 32-bit data type with default setting
- (8) Click OK to confirm the setting

Note: S475 device icon will appear after confirming the configuration. If more devices to be added, perform the same procedure as Step (1)-(8)

Note: Click Save Data and gateway will restart automatically. After restarting, device S475 is added successfully

5.2.1.6 Add S475 Datapoint

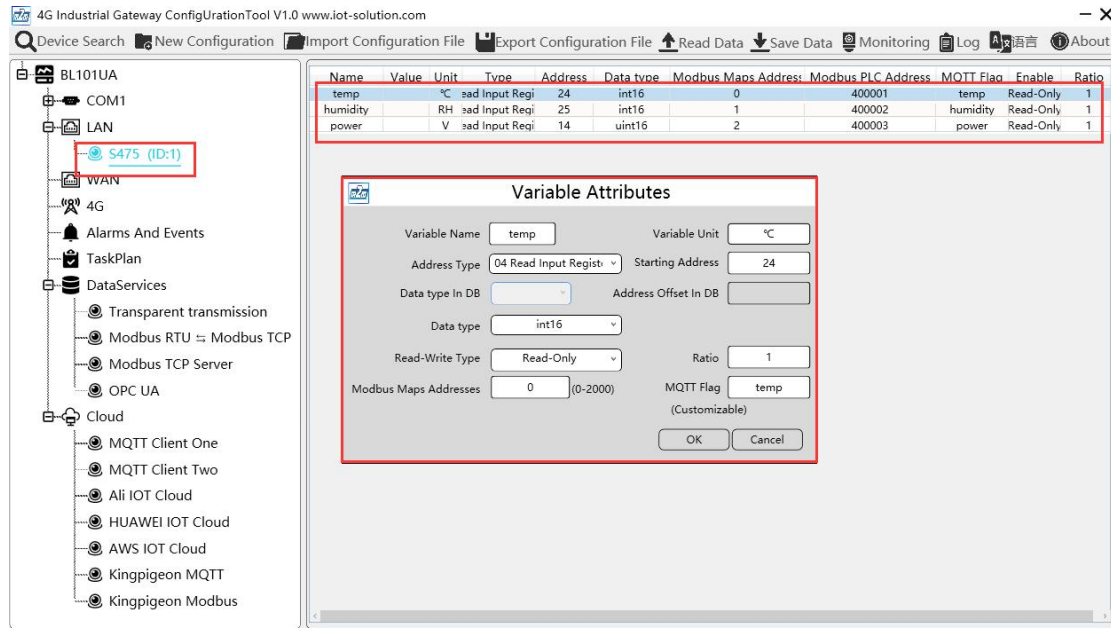

- (1) Click S475, move mouse cursor to the right box, right click the mouse and click Add to enter datapoint configuration box
- (2) Variable Name: Set the name of datapoint, for example, temperature
- (3) Address Type: S475 temperature supports function code 04, thus select 04 read input register
- (4) Data Type: S475 temperature is 16-bit signed numeric data, thus select int16
- (5) Read-Write Type: Automatic Identifying it according to Address Type
- (6) Variable Unit: °C(set any unit according to actual requirement)
- (7) Starting Address: 24 (Datapoint temperature register address in S475 is 24)
- (8) Adding Qty: If consecutive addresses to be collected, the same function code can collect it simultaneously.
- (9) Ratio: set the ratio to be multiplied or minified for uploading to cloud
- (10) Modbus Mapping Address: 0 (S475 temperature data is saved in register address 0 of BL101).
Modbus mapping address can be any from 0 to 2000 and it can't be repeated
- (11) MQTT Flag: temp. It can be any identification mark and can't be repeated.
- (12) Click OK to confirm.

Note: After confirming the configuration, datapoints will appear in the box like above picture. To add more datapoints, right click the box and click Add to enter configuration box. Perform the same procedure as Step (2)-(11)

Note: Click Save Data. Gateway will restart automatically. After device restarting, S475 datapoint is added successfully.

5.2.2 M140T & S475 Data Uploading to Clouds

Below examples are the procedures to uploading M140T & S475 data to Modbus TCP Server, OPC UA, Alibaba Cloud, HUAWEI Cloud, AWS, King Pigeon Cloud via MQTT, King Pigeon Cloud via Modbus.

MQTT Client One and MQTT Client Two are for private cloud, supporting connecting with certificate. The settings are the same as King Pigeon Cloud connection via MQTT. Thus it will not be described here.

5.2.2.1 Modbus TCP Server Configuration

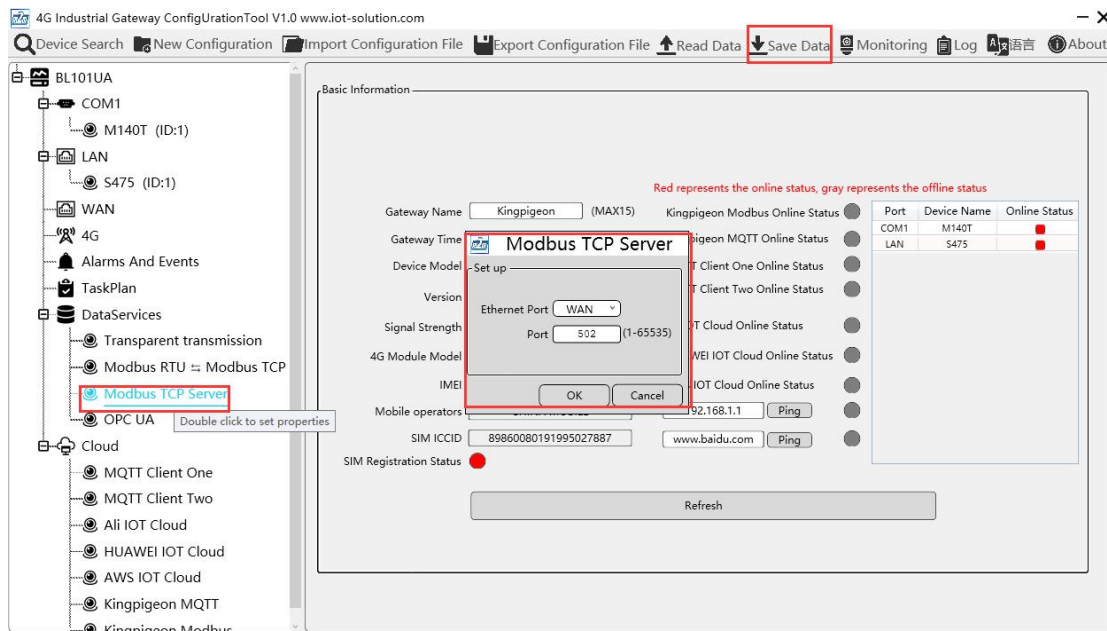

- (1) Double click Modbus TCP Server to enter configuration box
- (2) Ethernet Port: Select WAN (In this example, industrial router R40 is connected through WAN) . Click WAN to view its IP address: 192.168.1.197
- (3) Port: This gateway is used as Modbus TCP Server monitoring port. Input any port within range 1-65535. For example, put 502
- (4) Click OK to confirm the setting of Modbus TCP Server.
- (5) Click Save Data. Gateway will restart automatically. After restarting, Modbus TCP Server configuration is done successfully.

5.2.2.2 View Dat with KEPServerEX 6

Gateway provides data as Modbus TCP server. Modbus TCP host computer will

collect data from BL101, like SCADA, MES PCs. Below example is simulating KEPServerEX 6 as host computer to collect BL101 data.

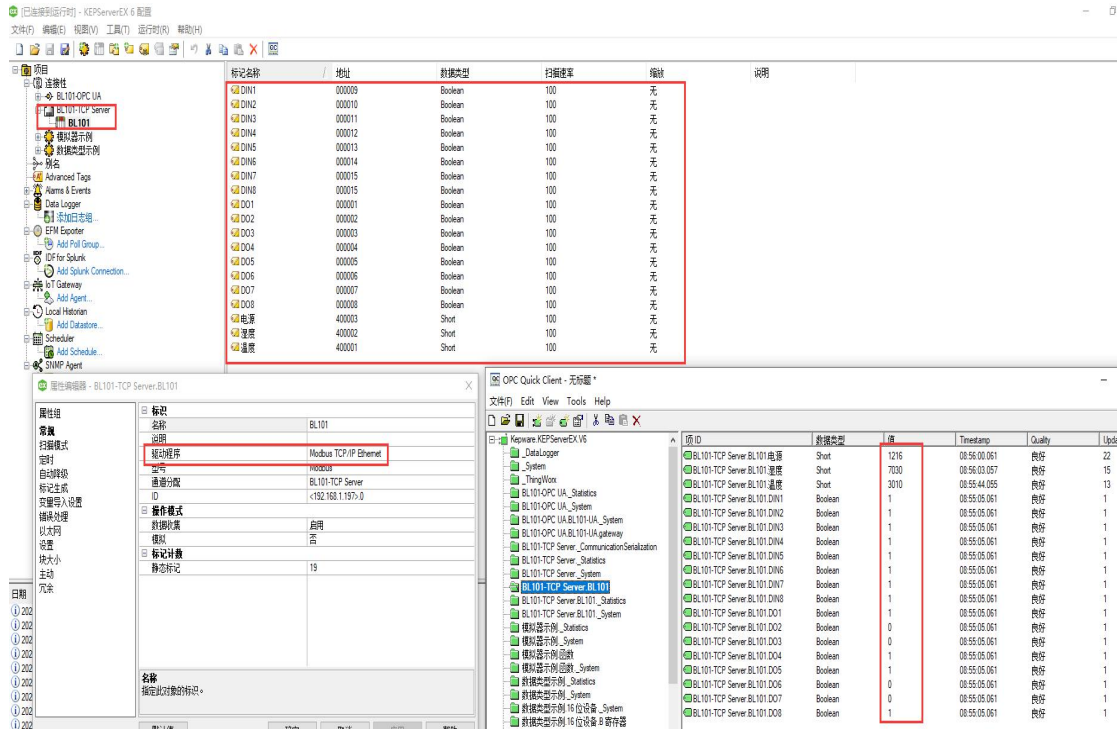

5.2.2.3 OPC UA Configuration

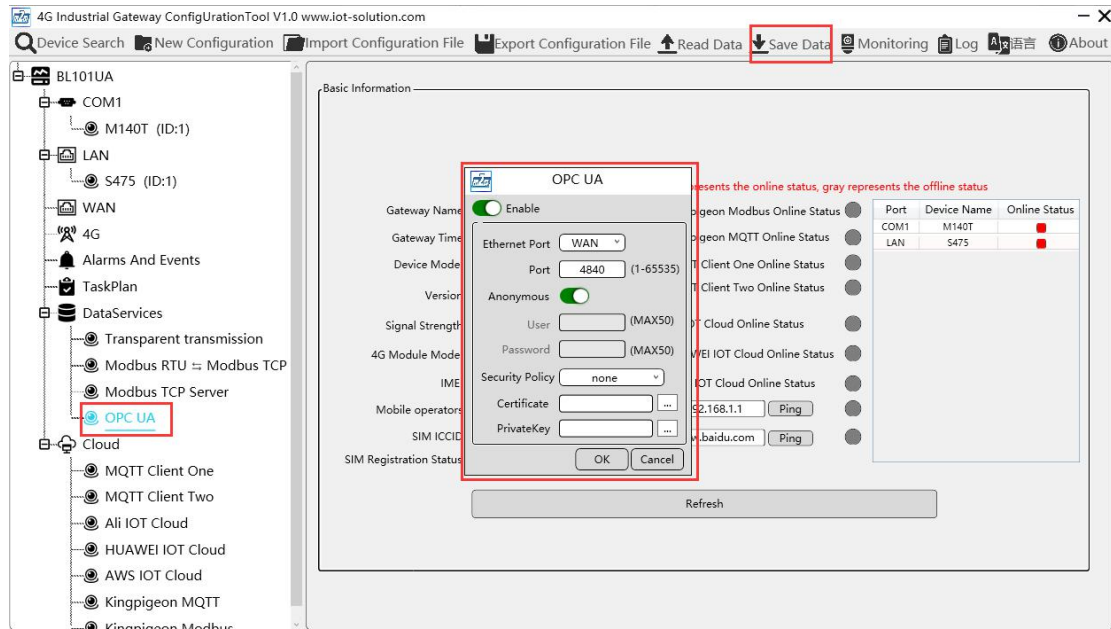

- (1) Double click OPC UA to enter configuration box
- (2) Click Enable to enable(green color) OPC UA. Default is disabled(gray color).
- (3) Ethernet Port: Select WAN (This example is connecting router R40 through WAN)

Click WAN to view its IP address: 192.168.1.197

- (4) Port: OPC UA Port, default is 4840
- (5) Anonymous: If enabled, OPC UA can be connected without ID and password
- (6) User, Password: only to be set when anonymous is disabled
- (7) Security Policy: Select connection encryption policy(This example is connecting without encryption, thus select None)
- (8) Certificate, PrivateKey: This example is connecting without encryption, then it's not necessary to upload certificate and privatekey.
- (9) Click OK to confirm OPC UA configuration
- (10) Click Save Data. Gateway will restart automatically. After device restarting, OPC UA is configured successfully.

5.2.2.4 View Data with KEPServerEX 6

BL101 provides data as OPC UA server. Use KEPServerEX 6 to view collected data as below picture:

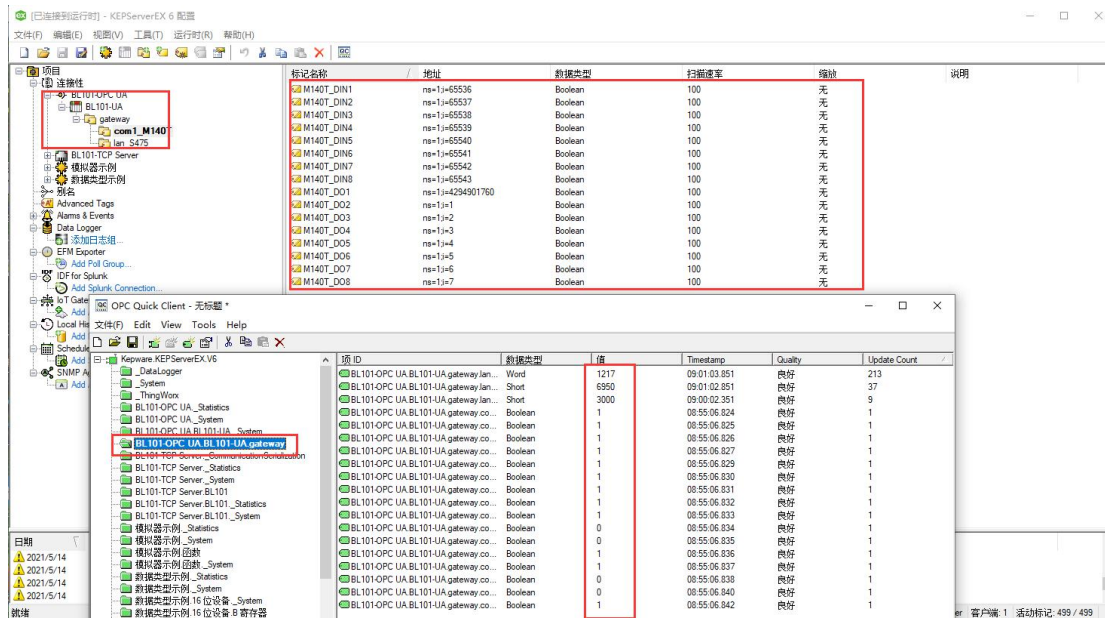

The screenshot shows the KEPServerEX 6 interface. On the left, the project tree shows a connection to 'BL101-UA' with a 'gateway' object. The main window displays a table of configured OPC UA variables:

标记名称	地址	数据类型	约简速率	缩放	说明
M140T_DIN1	ns=1-j=65536	Boolean	100	无	
M140T_DIN2	ns=1-j=65537	Boolean	100	无	
M140T_DIN3	ns=1-j=65538	Boolean	100	无	
M140T_DIN4	ns=1-j=65539	Boolean	100	无	
M140T_DIN5	ns=1-j=65540	Boolean	100	无	
M140T_DIN6	ns=1-j=65541	Boolean	100	无	
M140T_DIN7	ns=1-j=65542	Boolean	100	无	
M140T_DIN8	ns=1-j=65543	Boolean	100	无	
M140T_DO1	ns=1-j=4294901760	Boolean	100	无	
M140T_DO2	ns=1-j=1	Boolean	100	无	
M140T_DO3	ns=1-j=2	Boolean	100	无	
M140T_DO4	ns=1-j=3	Boolean	100	无	
M140T_DO5	ns=1-j=4	Boolean	100	无	
M140T_DO6	ns=1-j=5	Boolean	100	无	
M140T_DO7	ns=1-j=6	Boolean	100	无	
M140T_DO8	ns=1-j=7	Boolean	100	无	

Below this, a data monitoring table is visible with columns: 属性ID, 数据类型, 值, Timestamp, Quality, Update Count. The '值' column contains various numerical and boolean values, and the 'Quality' column shows '良好' (Good).

5.2.2.5 Alibaba Cloud Configuration

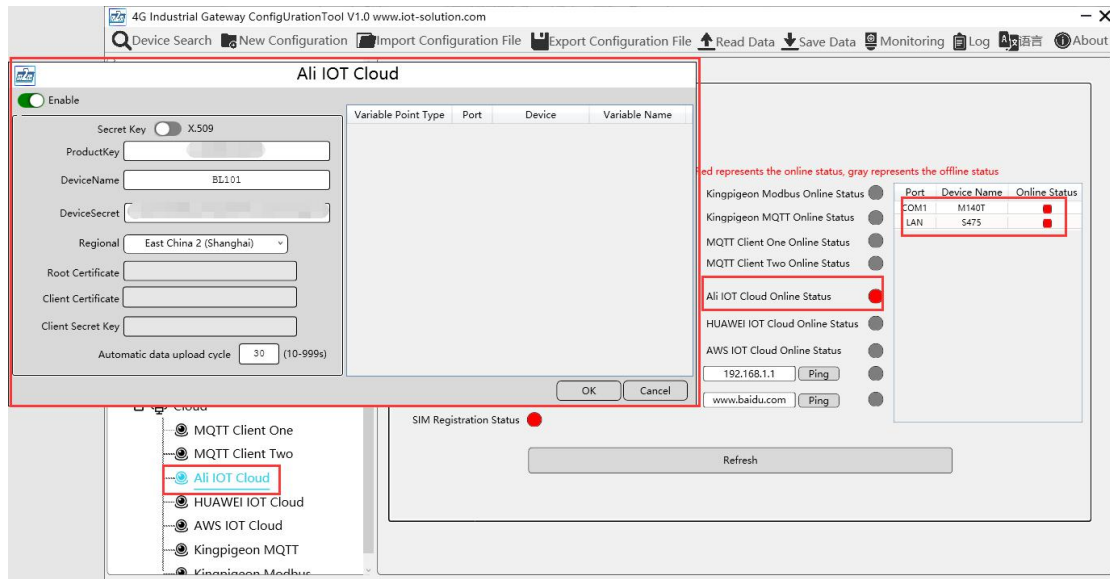

- (1) Double click Ali IOT Cloud to enter configuration box
- (2) Click Enable to enable(Green) Alibaba Cloud. Default is disabled (Gray)
- (3) Secret Key/X.509: Click it to move the button on the right for connecting with certificate. Default is connecting with Private Key with button on the left
- (4) Product Key: Input the same ProductKey as the one in Alibaba cloud
- (5) Device Name: Input the same device name as the one in Alibaba cloud
- (6) Device Secret: Input the same device secret as the one in Alibaba cloud
- (7) Region: Select Alibaba cloud region. Default is East China 2(Shanghai)
- (8) Root Certificate: Upload root certificate if connecting with certificate is enabled
- (9) Client Certificate: Upload client certificate if connecting with certificate is enabled
- (10) Client Secret Key: Upload client secret key if connecting with certificate is enabled
- (11) Automatic Data Upload Cycle: Cycle time of data uploading, default is 30s
- (12) Datapoint Uploading Selection: select the datapoints to be uploaded on the right box. In default the box is blank with all datapoints to be uploaded.
- (13) Click OK to confirm the setting
- (14) Click Save Data. Gateway will restart automatically and Alibaba cloud is enabled successfully. Open configuration software and login the device. Alibaba cloud connection status can be viewed from basic information. If indicator button is red, it means device is connected with Alibaba cloud. Slave device connection status can be viewed from the right box



5.2.2.6 View Data from Alibaba Cloud

Alibaba Cloud IoT Platform console showing TSL Data for a device. The 'TSL Data' tab is selected, and a table of data points is displayed. Red boxes highlight the 'Online' status, 'DeviceSecret', 'TSL Data' tab, and the data table.

Property Identifier	Property Name	Data Type	Update Time	Updated Value	Expected Value	Actions
DIN1	DIN1	bool	Jun 15, 2021, 20:14:26.337	1 (1)	-	View Data
DIN2	DIN2	bool	Jun 15, 2021, 20:14:26.337	1 (1)	-	View Data
DIN3	DIN3	bool	Jun 15, 2021, 20:14:26.337	1 (1)	-	View Data
DIN4	DIN4	bool	Jun 15, 2021, 20:14:26.337	1 (1)	-	View Data
DIN5	DIN5	bool	Jun 15, 2021, 20:14:26.337	1 (1)	-	View Data
DIN6	DIN6	bool	Jun 15, 2021, 20:14:26.337	1 (1)	-	View Data
DIN7	DIN7	bool	Jun 15, 2021, 20:14:26.337	1 (1)	-	View Data
DIN8	DIN8	bool	Jun 15, 2021, 20:14:26.337	1 (1)	-	View Data
DO1	DO1	bool	Jun 15, 2021, 20:14:26.337	1 (1)	-	View Data

Alibaba Cloud IoT Platform console showing TSL Data for a device. The 'Devices' menu item is highlighted, and a table of data points is displayed. Red boxes highlight the 'Devices' menu item and the data table.

Property Identifier	Property Name	Data Type	Update Time	Updated Value	Expected Value	Actions
DIN8	DIN8	bool	Jun 15, 2021, 20:21:30.812	1 (1)	-	View Data
DO1	DO1	bool	Jun 15, 2021, 20:21:30.812	1 (1)	-	View Data
DO2	DO2	bool	Jun 15, 2021, 20:21:30.812	1 (1)	-	View Data
DO3	DO3	bool	Jun 15, 2021, 20:21:30.812	1 (1)	-	View Data
DO4	DO4	bool	Jun 15, 2021, 20:21:30.812	1 (1)	-	View Data
DO5	DO5	bool	Jun 15, 2021, 20:21:30.812	0 (0)	-	View Data
DO6	DO6	bool	Jun 15, 2021, 20:21:30.812	0 (0)	-	View Data
DO7	DO7	bool	Jun 15, 2021, 20:21:30.812	0 (0)	-	View Data
DO8	DO8	bool	Jun 15, 2021, 20:21:30.812	0 (0)	-	View Data
humidity	humidity	int	Jun 15, 2021, 20:21:30.812	5780	-	View Data
temp	temp	int	Jun 15, 2021, 20:21:30.812	2730	-	View Data
GeoLocation	地理位置	struct	-	-	-	View Data

5.2.2.7 HUAWEI Cloud Configuration

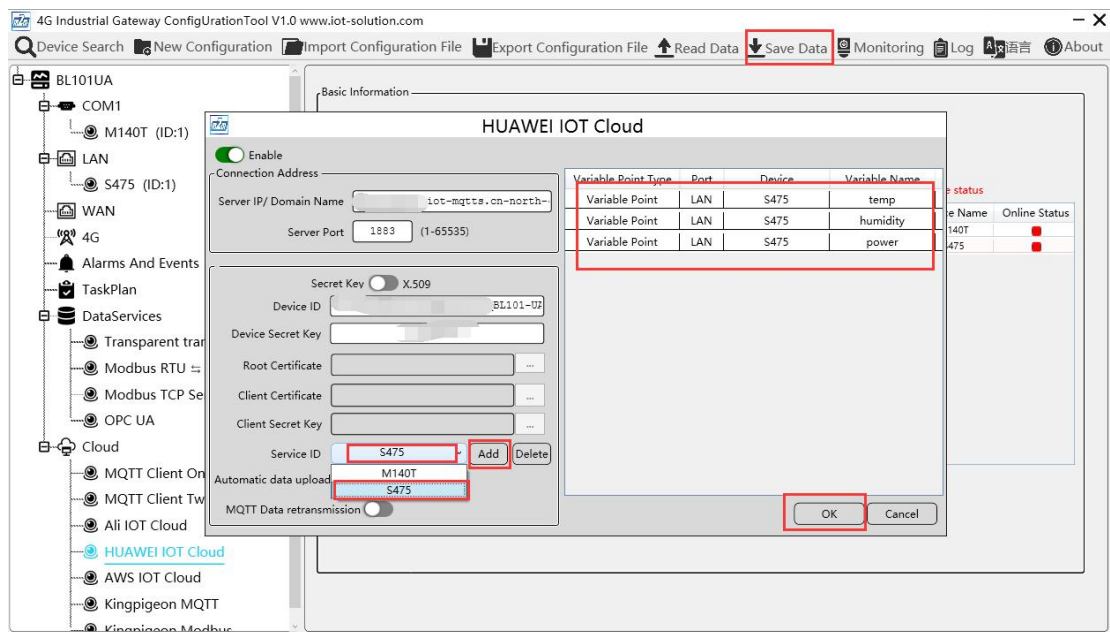
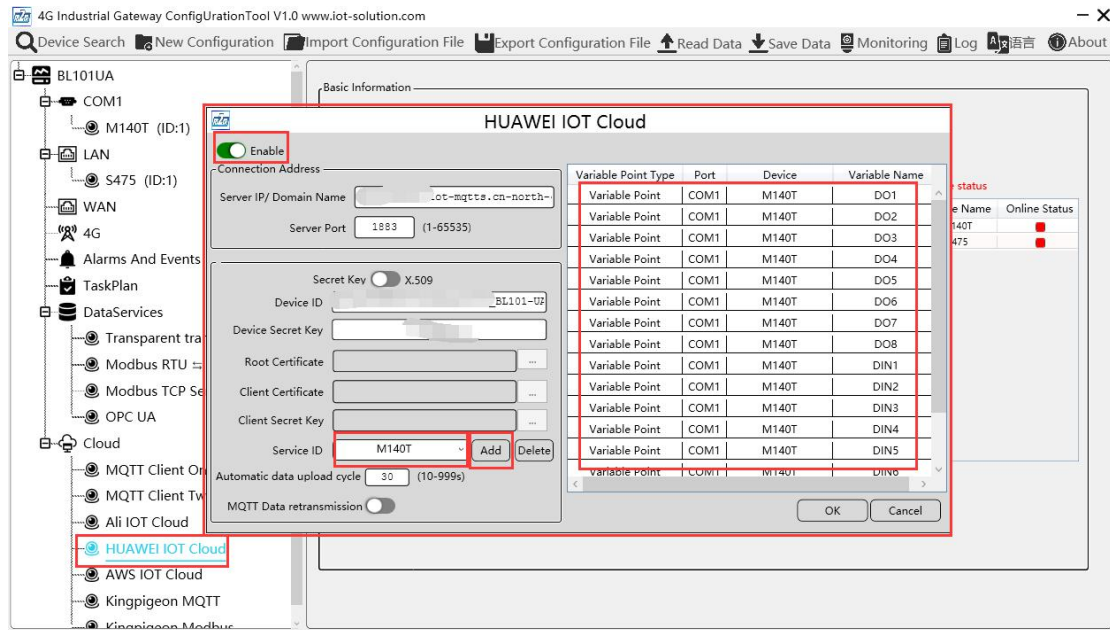

- (1) Double click HUAWEI IOT Cloud to enter configuration box
- (2) Click Enable to enable(green) HUAWEI Cloud. Default is disabled(gray)
- (3) Server IP/Domain Name: input HUAWEI Cloud connecting address(Login to HUAWEI Cloud, enter console, click overview to get server IP address)
- (4) Server Port: Default is 1883 for connecting with secret key. If connecting with certificate is selected, server port is 8883
- (5) Secret Key/X.509: click it to move the button on the right to set connecting with certificate. In default the button is on the left with setting of connecting with secret



Modbus to MQTT IoT Gateway

-BL101

key.

- (6) Device ID: set the same device ID as the one in HUAWEI Cloud
- (7) Device Secret Key: Set the same device secret key as the one in HUAWEI Cloud
- (8) Root Certificate: Upload root certificate if connecting with certificate is selected
- (9) Client Certificate: Upload client certificate if connecting with certificate is selected
- (10) Client Secret Key: Upload client secret key if connecting with certificate is selected.
- (11) Service ID: Input the same service ID as the one in HUAWEI Cloud. Multiple service IDs can be set. This example inputs M140T & S475 service IDs
- (12) Automatic Data Upload Cycle: Cycle time of uploading data, default is 30s
- (13) MQTT Data Retransmission: Click it to enable (green) MQTT offline data retransmission once network resumes. Gray indicates disabled
- (14) Datapoint Uploading Selection: Right click the box to select datapoints for uploading. In default the right box is blank with all datapoints to be uploaded. For example, select Service ID M140T datapoints to upload. Right click the box to enter datapoint box, select M140T datapoint DO1 and hold the mouse to drag it to uploading points. Click OK to confirm and the datapoint will appear in the box. Select service ID S475, right click the box to enter datapoint box, select datapoint and click OK to confirm it. Click OK to confirm HUAWEI Cloud configuration
- (15) Click Save Data. Gateway will restart automatically and HUAWEI Cloud is enabled successfully. Open gateway configuration software and login device. HUAWEI Cloud connection status can be viewed from basic information. Red indicates device is connected with HUAWEI Cloud. On the right side, slave device connection status can be viewed

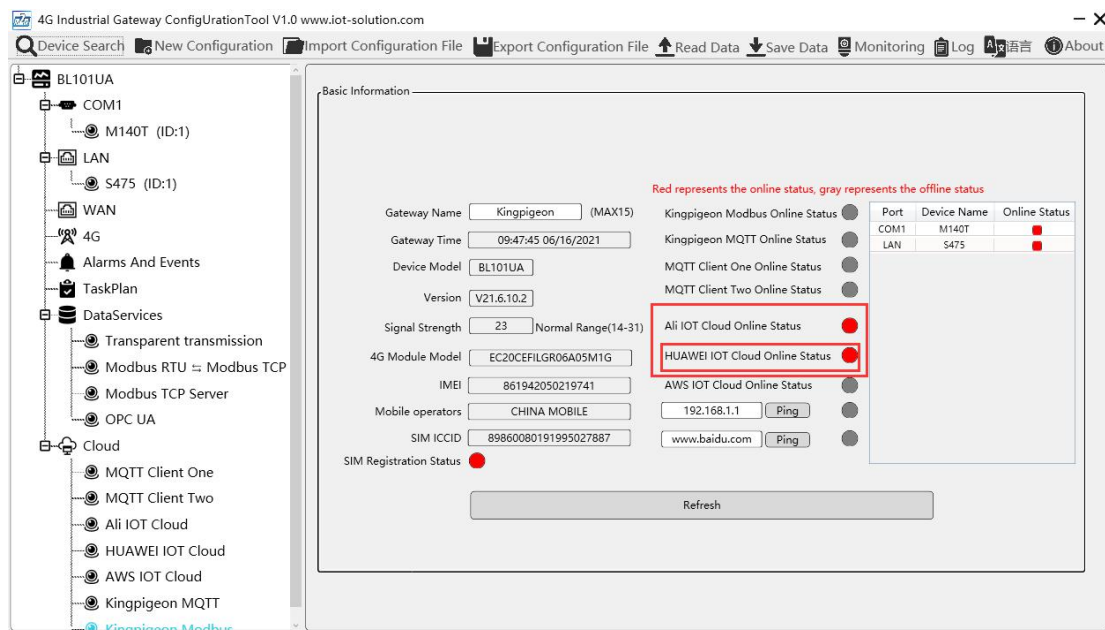

5.2.2.8 View Data from HUAWEI Cloud

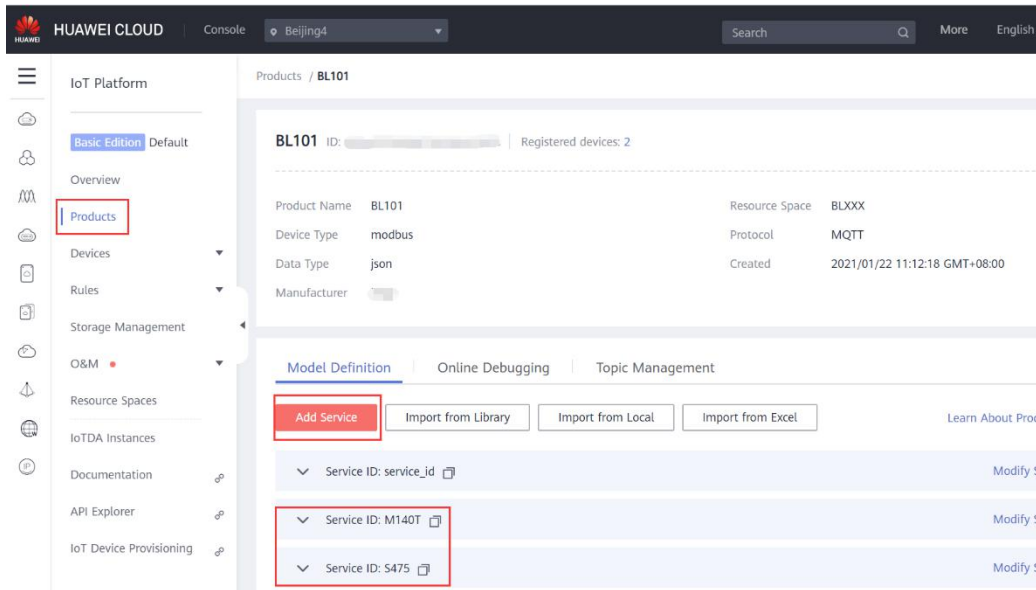

The screenshot shows the Huawei Cloud IoT Platform console. The left sidebar is expanded to 'Products'. The main content area displays details for product 'BL101'. The 'Add Service' button is highlighted with a red box. Below it, a table lists services with their IDs: 'service_id', 'M140T', and 'S475'. The 'S475' service ID is highlighted with a red box.

Service ID	Action
Service ID: service_id	Modify S
Service ID: M140T	Modify S
Service ID: S475	Modify S

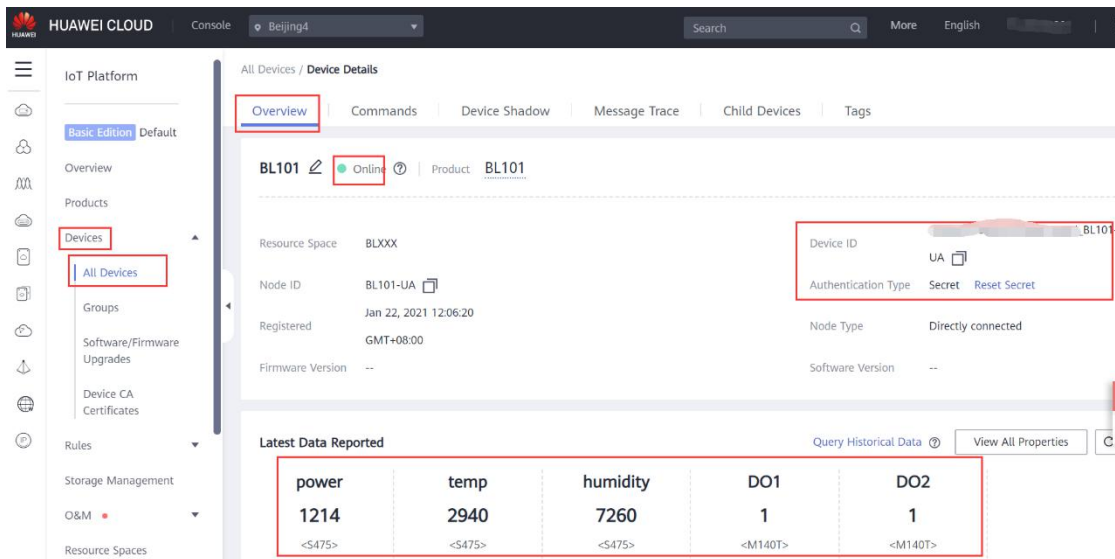

The screenshot shows the Huawei Cloud IoT Platform console for a specific device 'BL101'. The 'Overview' tab is selected. The device status is 'Online'. The 'Latest Data Reported' table is highlighted with a red box.

power	temp	humidity	DO1	DO2
1214	2940	7260	1	1
<S475>	<S475>	<S475>	<M140T>	<M140T>

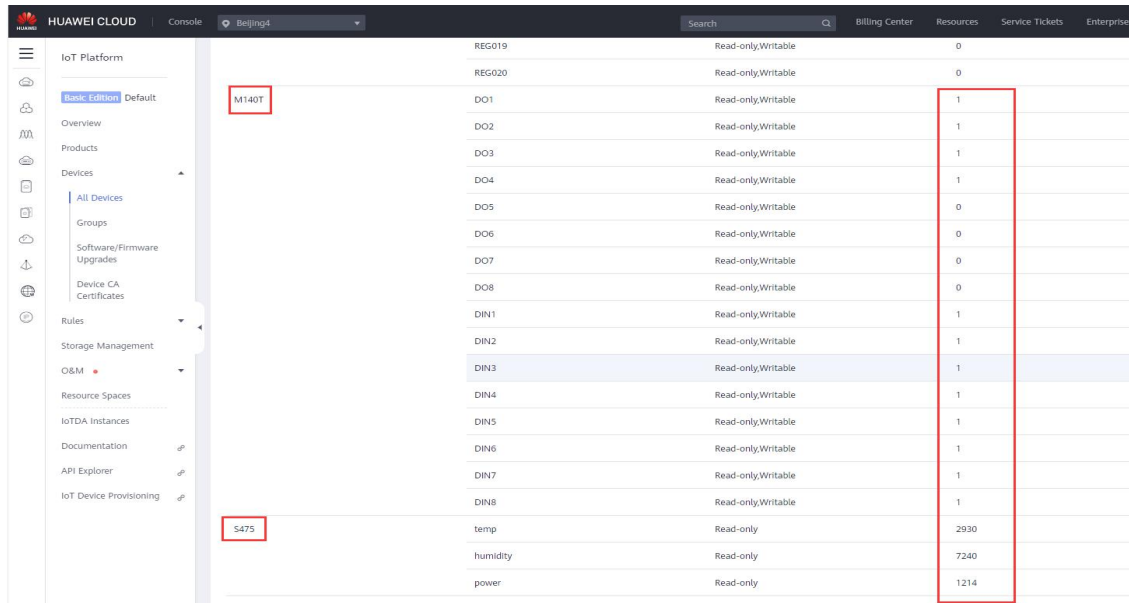

Variable Name	Access Mode	Value
REG019	Read-only,Writable	0
REG020	Read-only,Writable	0
DO1	Read-only,Writable	1
DO2	Read-only,Writable	1
DO3	Read-only,Writable	1
DO4	Read-only,Writable	1
DO5	Read-only,Writable	0
DO6	Read-only,Writable	0
DO7	Read-only,Writable	0
DO8	Read-only,Writable	0
DIN1	Read-only,Writable	1
DIN2	Read-only,Writable	1
DIN3	Read-only,Writable	1
DIN4	Read-only,Writable	1
DIN5	Read-only,Writable	1
DIN6	Read-only,Writable	1
DIN7	Read-only,Writable	1
DIN8	Read-only,Writable	1
temp	Read-only	2930
humidity	Read-only	7240
power	Read-only	1214

5.2.2.9 AWS Configuration

Multiple topics can be published in AWS. The configuration procedure is the same as that of configuring multiple service Ids in HUAWEI Cloud. Below example is single topic with all datapoints to be published.

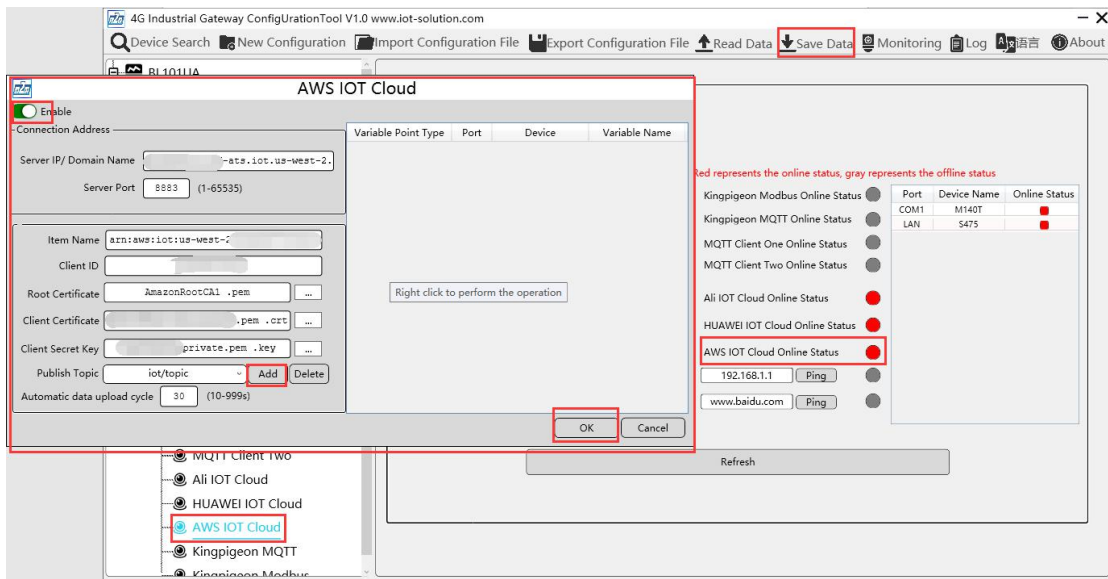

- (1) Double click ASW to enter configuration box
- (2) Click Enable to enable(green) ASW, default is disabled(gray)
- (3) Server IP/Domain Name: Input endpoint of connecting to AWS
(Login to ASW, enter console, click Things and click Interact to view it)
- (4) Server Port: 8883
- (5) Item Name: Input thing ARN(Click Details of Thing to view ARN in AWS)
- (6) Client ID: Input AWS Account ID (view from user information in AWS)

- (7) Root Certificate: Select root certificate and upload it
- (8) Client Certificate: Select client certificate and upload it
- (9) Client Secret Key: Select client secret key and upload it.
- (10) Publish Topic: Input the topic of rule created in AWS. It's the topic of MQTT message publishing. Click Add to set more publishing topics. Click Delete to delete selected topic. For example, login to AWS, click Act and click Rules to view the topic. It's iot/topic, thus input iot/topic

Rule query statement

The source of the messages you want to process with this rule.

```
SELECT * FROM 'iot/topic'
```

- (11) Automatic Data Upload Cycle: Cycle time of uploading data, default is 30s.
- (12) Datapoint Uploading Selection: Select datapoint to upload in the right box. Default is blank box with all datapoints to be uploaded
- (13) Click OK to confirm AWS configuration
- (14) Click Save Data. Gateway will restart and AWS is enabled successfully. Open configuration software and login the device. AWS connection status can be viewed from basic information. Red light indicates AWS is connected. Slave device connection status can be viewed from the right box

5.2.2.10 View Data from AWS

Login to ASW, click Act, click Test and select subscription topic "iot/topic" to view messages published by BL101 gateway

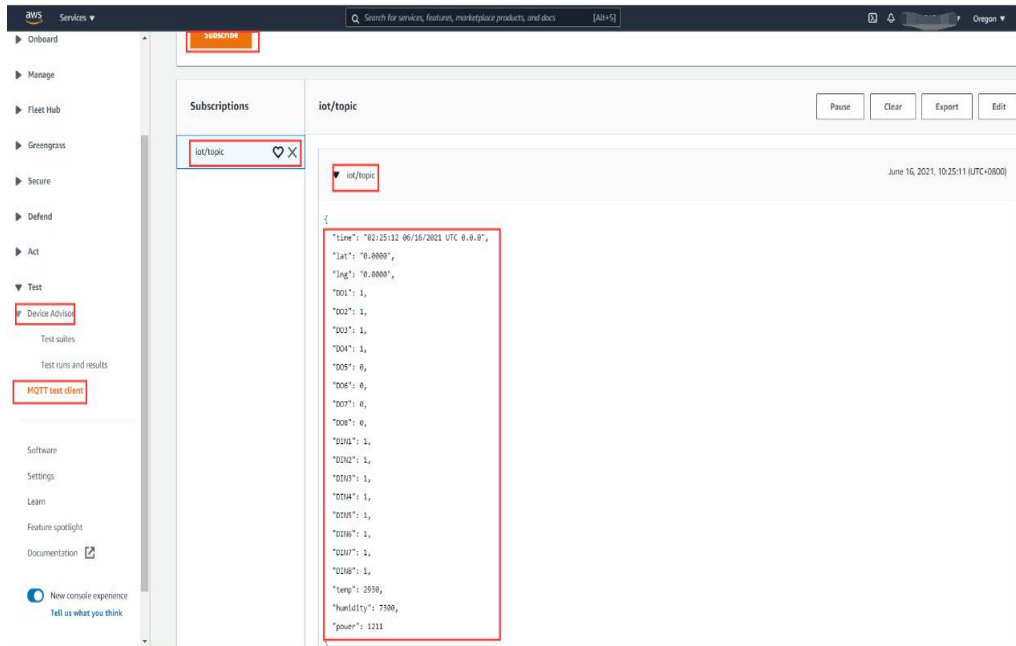

5.2.2.11 King Pigeon Cloud via Modbus Configuration

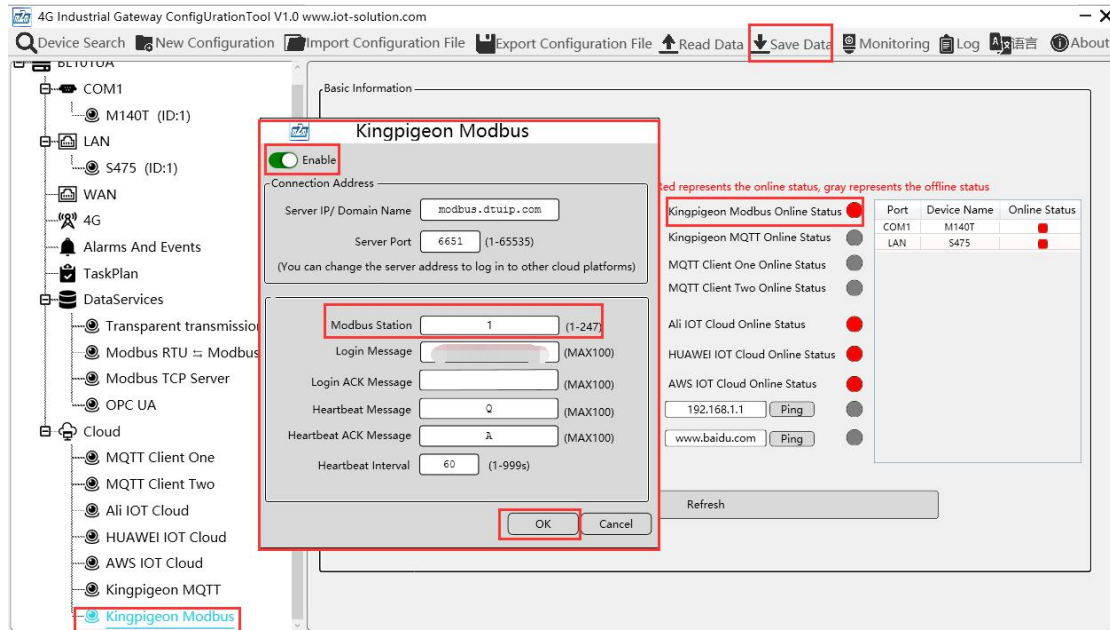

- (1) Double click KingPigeon Modbus to enter configuration window
- (2) Click Enable to enable(green) King Pigeon cloud via Modbus. Default is disabled (Gray)
- (3) Server IP/Domain Name: modbus.dtuip.com. (Automatic filling in default)
- (4) Server Port: 6651 (Automatic filling in default)
- (5) Modbus Station: Set BL101 gateway Modbus communication address
- (6) Login Message: Input device serial number issued by King Pigeon.
- (7) Login ACK Message: Not necessary for King Pigeon cloud connection
- (8) Heatbeat Message: Q (Automatic filling in default)
- (9) Heatbeat ACK Message: A(Automatic filling in default)
- (10) Heatbeat Interval: Set cycle time of sending heartbeat message. Default is 60s
- (11) Click OK to confirm the configuration.
- (12) Click Save Data. Gateway will restart and King Pigeon Cloud via Modbus is enabled successfully. Open configuration software and login device. King Pigeon cloud via Modbus connection status can be viewed from basic information. Red indicates device is connected King Pigeon cloud via Modbus. Slave devices connection status can be viewed from the right box.

5.2.2.12 View Data from King Pigeon Cloud via Modbus

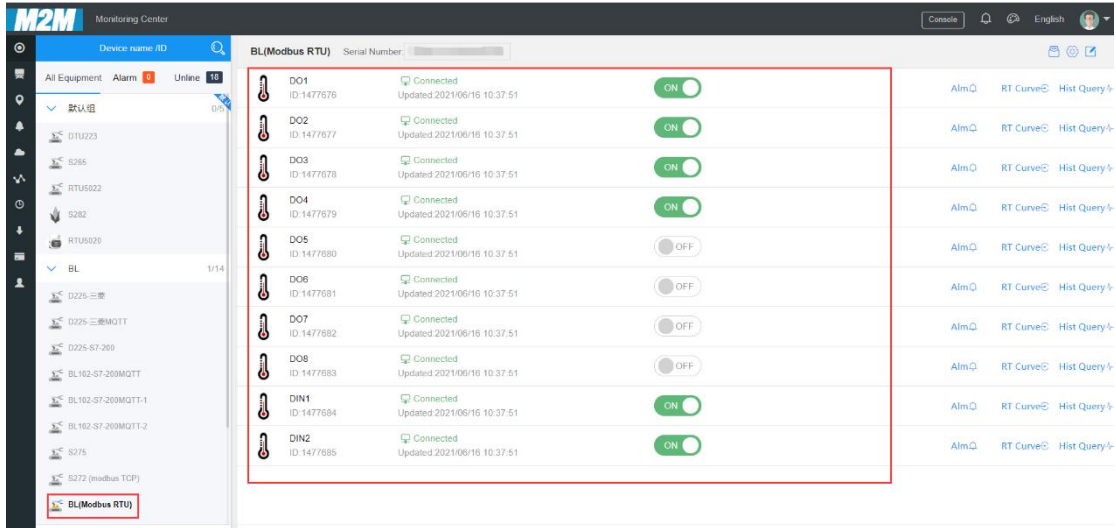

The screenshot shows the M2M Monitoring Center interface for a BL(Modbus RTU) device. The left sidebar lists various equipment, with 'BL' selected. The main panel displays a table of digital outputs and inputs:

ID	Status	Updated	Control	Alm	RT Curve	Hist Query
DO1	Connected	2021/06/16 10:37:51	ON	Alm	RT Curve	Hist Query
DO2	Connected	2021/06/16 10:37:51	ON	Alm	RT Curve	Hist Query
DO3	Connected	2021/06/16 10:37:51	ON	Alm	RT Curve	Hist Query
DO4	Connected	2021/06/16 10:37:51	ON	Alm	RT Curve	Hist Query
DO5	Connected	2021/06/16 10:37:51	OFF	Alm	RT Curve	Hist Query
DO6	Connected	2021/06/16 10:37:51	OFF	Alm	RT Curve	Hist Query
DO7	Connected	2021/06/16 10:37:51	OFF	Alm	RT Curve	Hist Query
DO8	Connected	2021/06/16 10:37:51	OFF	Alm	RT Curve	Hist Query
DIN1	Connected	2021/06/16 10:37:51	ON	Alm	RT Curve	Hist Query
DIN2	Connected	2021/06/16 10:37:51	ON	Alm	RT Curve	Hist Query

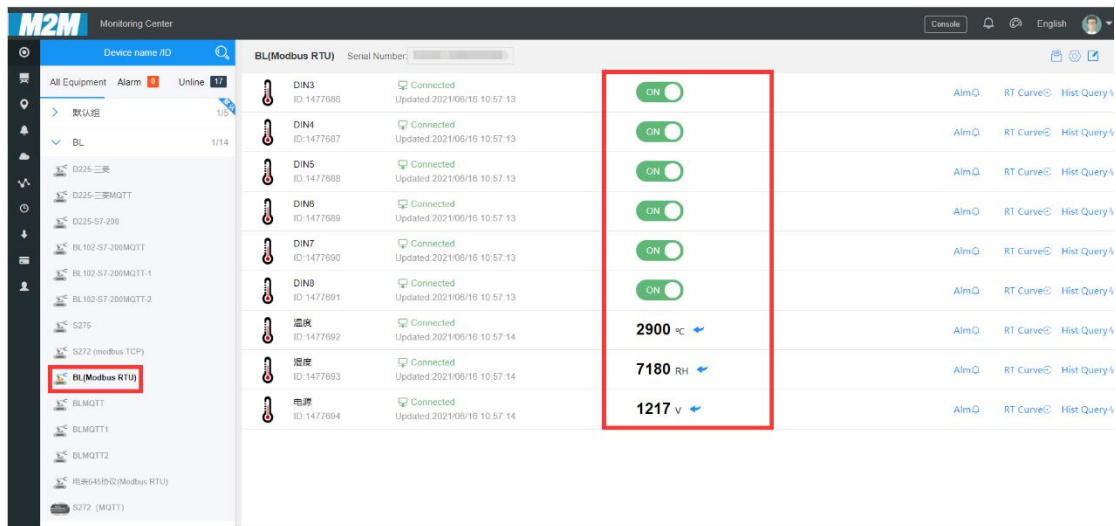

The screenshot shows the M2M Monitoring Center interface for a BL(Modbus RTU) device. The left sidebar lists various equipment, with 'BL' selected. The main panel displays a table of digital inputs and analog data:

ID	Status	Updated	Value	Alm	RT Curve	Hist Query
DIN3	Connected	2021/06/16 10:57:13	ON	Alm	RT Curve	Hist Query
DIN4	Connected	2021/06/16 10:57:13	ON	Alm	RT Curve	Hist Query
DIN5	Connected	2021/06/16 10:57:13	ON	Alm	RT Curve	Hist Query
DIN6	Connected	2021/06/16 10:57:13	ON	Alm	RT Curve	Hist Query
DIN7	Connected	2021/06/16 10:57:13	ON	Alm	RT Curve	Hist Query
DIN8	Connected	2021/06/16 10:57:13	ON	Alm	RT Curve	Hist Query
温度	Connected	2021/06/16 10:57:14	2900 °C	Alm	RT Curve	Hist Query
湿度	Connected	2021/06/16 10:57:14	7180 Rh	Alm	RT Curve	Hist Query
电源	Connected	2021/06/16 10:57:14	1217 v	Alm	RT Curve	Hist Query

5.2.2.13 King Pigeon Cloud via MQTT Configuration

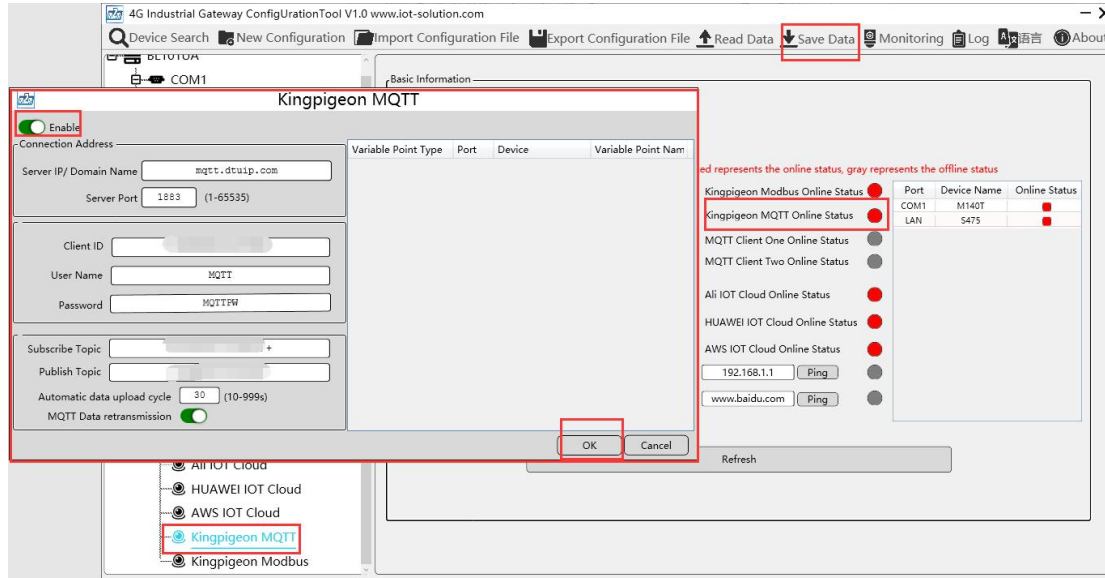

- (1) Double click King Pigeon MQTT to enter configuration box
- (2) Click Enable to enable (green) King Pigeon cloud connection via MQTT. Default is disabled (gray)
- (3) Server IP/Domain Name: mqtt.dtuip.com (Automatic filling in default)
- (4) Server Port: 1883 (Automatic filling in default)
- (5) Client ID: Input device serial number issued by King Pigeon
- (6) User Name: MQTT (Automatic filling in default)
- (7) Password: MQTTPW (Automatic filling in default)
- (8) Subscribe Topic: Input device serial number/+ issued by King Pigeon
- (9) Publish Topic: Input device serial number issued by King Pigeon.
- (10) Automatic Data Upload Cycle: Cycle time of uploading data. In default it's 30s
- (11) MQTT Data Retransmission: Click it to enable (green) offline data retransmission once network resumes.
- (12) Datapoint Uploading Selection: Select the datapoint to upload in the right box. In default it's blank with all datapoints to be uploaded
- (13) Click OK to confirm King Pigeon Cloud via MQTT configuration
- (14) Click Save Data. Gateway will restart and King Pigeon Cloud via MQTT is configured successfully. Open configuration software and login the device. King Pigeon Cloud connection status via MQTT can be viewed from basic information. Red indicates King Pigeon cloud via MQTT is connected. Slave device connection status can be viewed from the right box.

5.2.2.14 View Data from King Pigeon Cloud via MQTT

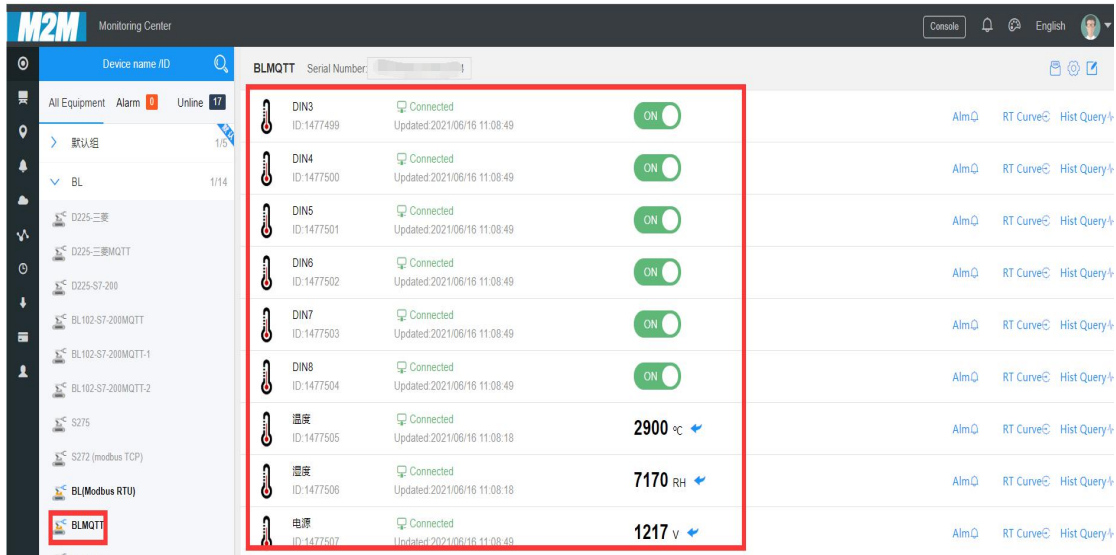
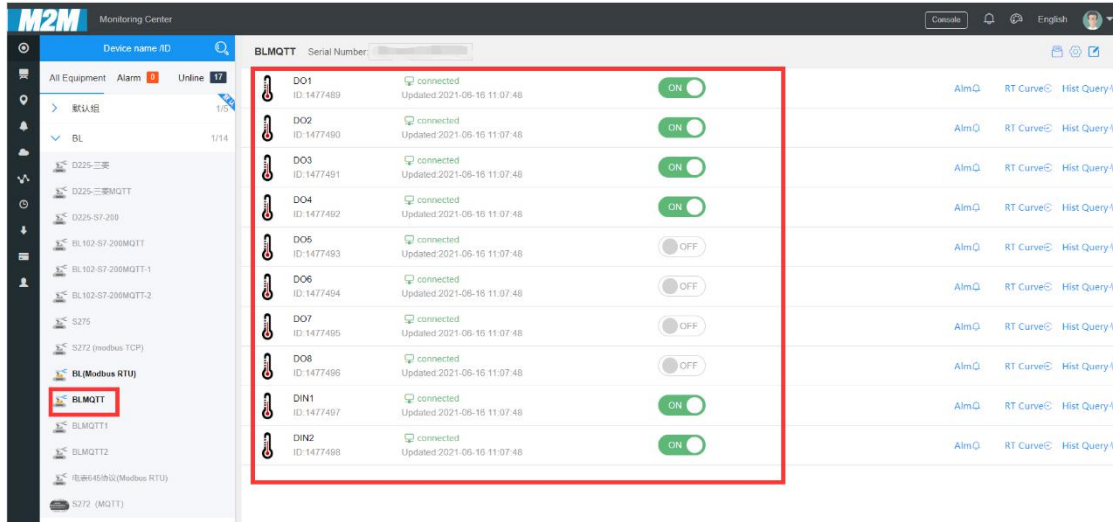

5.2.2.15 King Pigeon Cloud MQTT Message Format

MQTT Client One , MQTT Client Two and King Pigeon Cloud MQTT data formats are the same. See below:

(1) Valid Load Data Format in device Publishing messages

Publish Topic: Serial Number (Configured publish topic)

```
{
  "sensorDatas": [
    {
      //Boolean value
      "flag": "REG001", //Read-write identification mark
    }
  ]
}
```

```

"switcher": 0 //Data Type and Value
},
{
//Numeric Type
"flag": "REG005", //Read-Write identification mark
"value": 3 //Data Type and Value
}
],
"state": "alarm", //Alarm mark(Set Alarm Event in configuration software. Once
alarm is trigger, this mark will appear. It's not included in scheduled automatically
uploaded data)
"state": "recovery", //Alarm recovery mark (Only appear when there's alarm
recovery. It's not included in scheduled automatically uploaded data)
"time": "1622700769", //Time mark, it's time stamp of data uploading
"addTime": "2021-06-03 06:12:49" //Time mark, it's time of device data uploading
"retransmit": "enable" //Retransmission mark, MQTT historical data (Only appear
when there's historical data retransmission. It's not included in scheduled
automatically uploaded data)
}

```

Note:

//Read-Wrie Mark: character is "flag", followed by " Datapoint MQTT flag", it's the MQTT mark set in configuration software when adding datapoint.

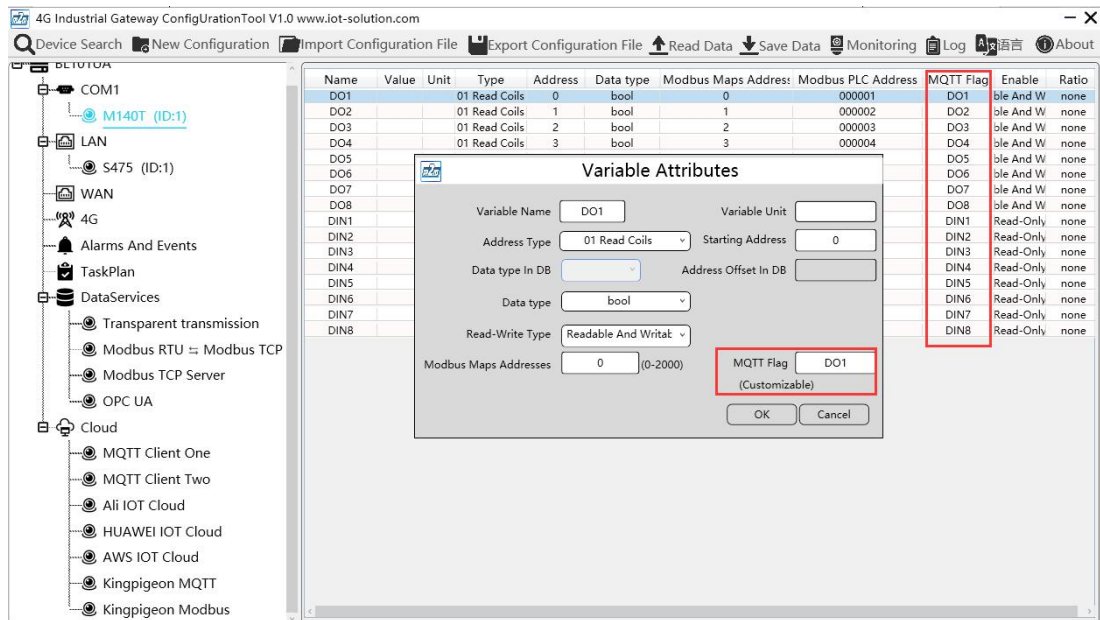

//Data Type and Value:

- 1) Boolean data: character is "switcher", followed by "0" or "1"(0 represents open, 1 represents close)



2) Numeric Data: character is "value", followed by actual value
//Alarm, Recover mark, character is "state", followed by "alarm" or "recovery"(alarm represents alarm data, recovery represents alarm recovery data)
//Time mark: character is "time", followed by actually data uploading timestamp
//Time mark, character is "addtime", followed by "gateway time"
//Retransmission mark: character is "retransmit", followed by "enable"
Offline collected data will be temporarily saved in gateway device. Once network resumes, the data will be retransmitted. Use "retransmit" mark for historical data (MQTT Data Retransmission must be enabled in configuration software)

(2) Valid Load Data Format in device Subscribing messages

Subscribe Topic: Serial Number/+ (Subscribe topic set in configuration software)
(King Pigeon cloud message publishing topic is "serial number/sensor ID", thus wildcard "/" must be added for device Subscribing Topic so that cloud can publishing data for controlling)

```
{
  "sensorDatas":
  [
    {
      "sensorId": 211267, // cloud sensor ID
      "switcher":1, //Data Type and Value
      "flag":"REG001" //Read-Write Mark
    }
  ],
  "down":"down" //Cloud downlink message mark
}
```

Note:

//cloud sensor ID: character is "sensorID", followed by ID (automatically generated by cloud. Not necessary if it's self-built cloud)

//Data Type and Value:

1) Boolean Data: character is "switcher", followed by "0" or "1"
(0 represents open, 1 represents close)

2) Numeric Data: character is "value", followed by "actual value"

//Read-Write Mark: character is "flag", followed by "datapoint MQTT flag"

//Cloud Downlink Message Mark: character is "down", followed by "down", representing cloud downlink data.



6 Firmware Upgrading

Please contact King Pigeon if it's necessary to upgrade firmware for any new requirements

7 Warranty Term

- 1) Warranty period is 1 year from the date of purchase. If any quality issues within warranty period, it will be repaired for free.
- 2) Device fault caused by wrong operation is beyond warranty.

8 Technical Support

King Pigeon Communication Co., Ltd.

Telephone: 0086-755-29451836

Website: www.iot-solution.com